

Issue 405
Ride Till Dawn

EBC[®]

BRAKES



AMERICAN-BUILT MACHINES
THE WORLD'S LARGEST RANGE OF PREMIUM
REPLACEMENT MOTORCYCLE BRAKES

Brake pads, rotors, braided stainless brake lines, clutches and much more, with four manufacturing plants in the UK and USA producing over 10 million components each year.

www.ebcbrakes.com

MOTORCYCLE BRAKE PADS

FA-Series – Aramid Fiber Organic

- Organic pad with zero metallic content
- Good fingertip feel at the lever
- Low noise
- Easy on rotors
- Medium lifetime pad
- British made



V-Series

- Superb “semi sintered “replacement pad for heavier bikes top - selling grade
- Zero metallic but some copper content for longer life
- Zero rotor damage or noise
- Lifetime almost as good as sintered
- British Made



Double-H™

- USA made in our Ohio plant
- Sintered copper alloy construction
- Superb high brake effect pad outlasting just about everything
- Great pad for heavier touring bikes and sport use
- Zero rotor galling



EPFA-series

- USA made in our Ohio plant
- High spec Sintered copper alloy construction
- Strongest brake feel
- Zero rotor galling
- Higher heat tolerance for heaviest duty street riding



GPFA-Series

- USA made in our Ohio plant
- Higher spec track use formulation
- Sintered copper alloy construction
- Not recommended for street riding due to very high friction level



CONTENTS

Welcome	2
Stainless Steel Slider Shims/Tech Tips	3
Oversize Rotors/Brake Fluid	4
Clutch Kits and Springs/EBC Brakes Jets	5
Harley-Davidson® Electric	6
Harley-Davidson® Adventure Touring	6
Harley-Davidson® Street	6
Harley-Davidson® Sportster	6
Harley-Davidson® Sportster RH	8
Harley-Davidson® Dyna	8
Harley-Davidson® Softail	8
Harley-Davidson® Softail	10
Harley-Davidson® Touring	12
Harley-Davidson® Trike	14
Harley-Davidson® CVO	14
Harley-Davidson® V-Rod	14
Arch	16
ATK	16
Buell	16
Can-Am Canyon	18
Can-Am Ryker	18
Can-Am Spyder	18
EBR	18
Indian	18
Indian	20
Motus	22
Polaris Slingshot	22
Victory	22
Zero Electric	24
Pads For Aftermarket Calipers	26
Brake Pad Buyers Guide (inc. dimensions)	27-32
Rotor Designs and Dimensions	33-49
Brake Lines	50-53
Clutch Kits, Springs and Installation Tools	54-71
Polaris Slingshot Parts	72

WELCOME TO THE EBC 2025 USA-BUILT MOTORCYCLE CATALOG

The world's largest selection of brakes for USA-built motorcycles including our USA-manufactured, sintered pad ranges and UK-made organic and semi-sintered Vee-pads plus a full range and selection of custom replacement brake rotors.

HOW TO USE THIS CATALOG

Pads are simple; simply look up the machine and select the pad type that's best for your customer. On rotors there are sometimes too many choices to list in columns so we use a group number in those cases and you simply take the group number, look at the illustrations and select the one you prefer; solid, floating or oversize.

EBC make different compounds for most calipers and as a guide. FA is the premium Organic grade, X pads are a dry conditions off road pad, V pads are our long lasting semi sintered pad for street use. R pads are a long lasting off road compound, HH is our USA made sintered metal highest brake effect pad, EPFA is our premium Sintered pad, also USA made with super quiet braking and highest temperature capabilities.

KEY TO SYMBOLS

- ⊕ This rotor is made of billet steel and should only be used with EBC FA Organic or Vee Pads.
- * Two sets of brake pads are required for this fitment.
- ▲ Pads sold in axle sets – 4 pads per set.

FULLY FLOATING

OVERSIZE FRONT ROTORS FOR HARLEY-DAVIDSON® RANGE PAGE 34/39/42

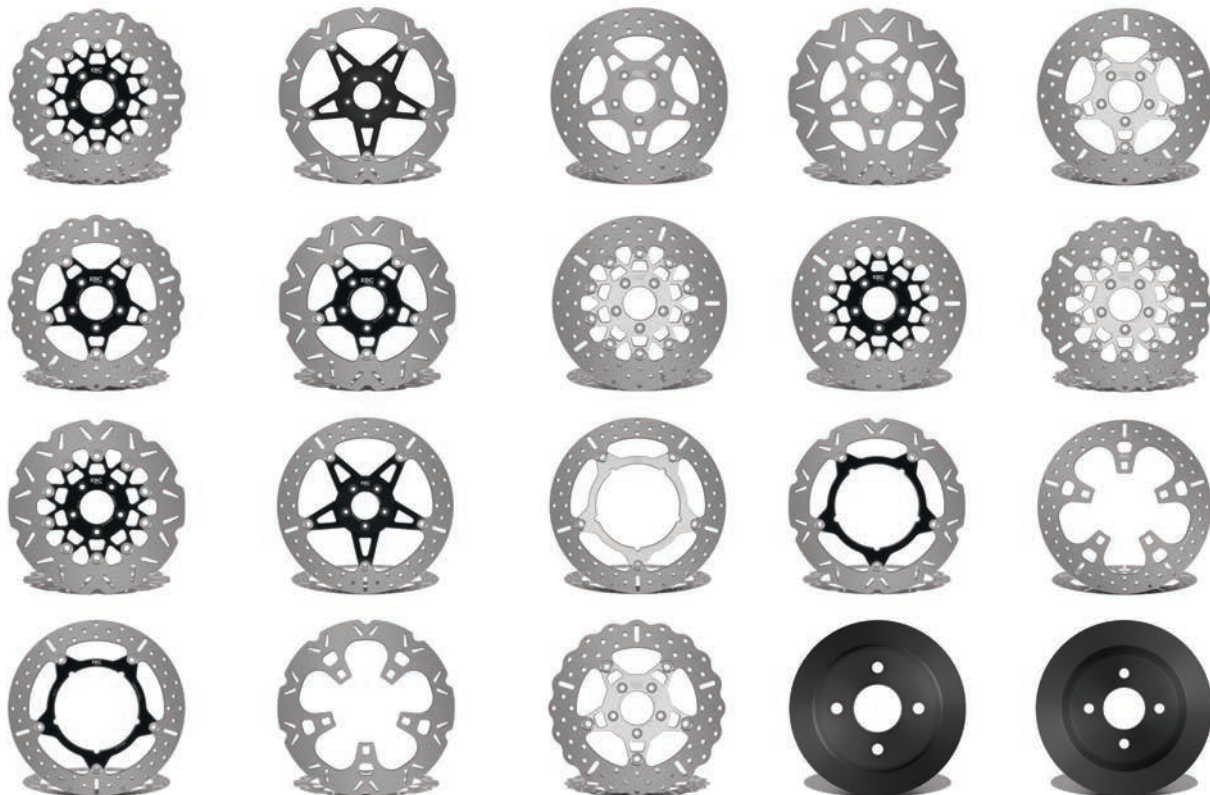

**TRIKE ROTORS IN CAST IRON
SEE PAGE 45**

STAINLESS STEEL SLIDER SHIMS

Stainless steel slider shims are fitted to most of the Hayes rear calipers on Harley Davidson® to prevent wear of the machined aluminum caliper “vee” slider faces and new parts are provided with EBC pads. The important things to note are:



After install, the pads must slide freely within the caliper without dragging and here is the basic procedure to install which is to be read and considered along with your vehicle owners' manual content.



If your bike had NO shims at pad change, do not try to fit shims that needs forcing into the caliper or would render the pads tight or locked UNLESS the pads were loose and rattling (indicating that at a previous service the bike owner or service technician may have forgotten to install shims when they were needed).



Clean up the aluminium slider faces carefully removing all corrosion and scale. Use a fine file or a file wrapped in abrasive paper and remember you are only cleaning off corrosion and scale.



Lightly lube the slider with high temp EBC caliper grease or similar, taking care not to contaminate pads with grease or greasy fingers. Grease on pads renders them ineffective.



Install the stainless slider shims.



Clean off any paint or burrs in the ears of the pads with a fine file and slip them onto the slider shims. The pads should be a light push fit with thumbs and if you have to force them you have either left scale or corrosion under the shims, the ears of the pad have paint or burrs in them or your caliper model did NOT need shims. Never force or hammer the pads into the caliper.



If you have any doubts contact a qualified service technician.



After brake install, raise the bike wheel and rotate the wheel, pumping and releasing the brakes to check for free spinning of the wheel and free releasing of the brakes. Test ride vehicle carefully applying the brakes intermittently for a few miles to evaluate brake drag and brake release. If rotors become blued or hot spotted or seem in anyway to be overheating, see a qualified technician. Do not ride the bike with dragging brakes.

TECH TIPS



MOST EBC PADS are not designed to re-use any original **BACKING SHIMS**. See pad diagrams for guidance on where shims may be refitted without causing problems, but even then, always check caliper mounts easily over the rotor and has a few thousandths of free float, and is not tight or causing drag, rotate wheels and operate brakes a few times with wheel lifted to check for free brake and no drag.



EBC front pads, reference FA94 are supplied with a larger (stronger) retainer screw, this has a different thread to the original parts and this screw should only be used with the EBC product.



Always caution the vehicle user/owner to check pad wear every month visually or after 3000 miles of riding, and replace pads when 1/16" of material left on backing plates. Running pads below this level is dangerous.



Many US built motorcycles use **SILICONE BRAKE FLUID**, always check carefully in the owners manual as to which fluid is required, never mix silicone fluids with glycols as this will cause sludging and ineffective brakes.



No EBC pads have ever contained asbestos, but some low cost aftermarket brands you look to replace may have. Therefore, always observe safety procedures when removing old pads and cleaning away dust. Use a wet cloth and dispose of safely after use.



All EBC organic pads now feature the revolutionary **Nucap®** (Canada) **NRS®** hook system. This guarantees the perfection of bond strength on pads. This allows EBC to use even chromed backing plates as the puck itself is retained by strong Velcro-like fingers that protrude about 1/32" into the pad material.



When installing new pads and/or rotors always advise the rider to bed in brakes gently, using progressively stronger braking pressure over the first 300-500 miles, riding the vehicle slowly, and allowing extra braking distance until the brakes feel strong.

OVERSIZE ROTORS

EBC Brakes range of 14" and 15" oversize full floating front rotors come with billet aluminum caliper relocation brackets. Plain rotors with a choice of polished or black chrome hubs are available for all big twins to improve brake performance and brake modulation, increasing stopping power by 25-30%. 15" rotors for single front fitments are made with a 6mm ¼" thick rotor blade.

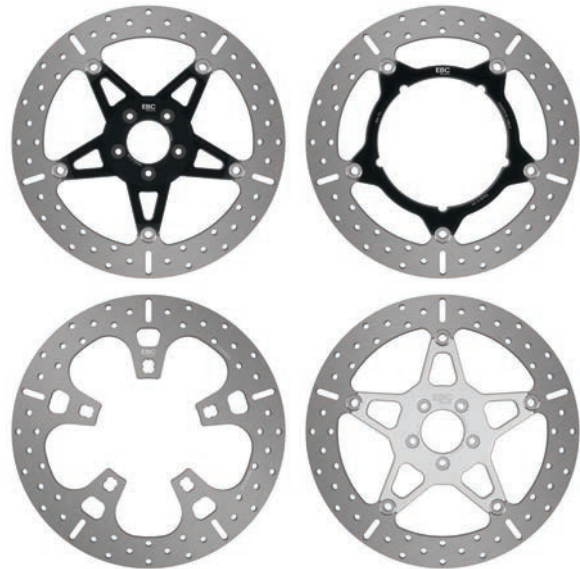

CALIPER RELOCATION BRACKET



BRAKE FLUID

Now tested to meet Florida EPA requirements. Bottle label shows all specifications of the fluid.



DOT 4

A refined specification polyglycol fluid as fitted to most faster street bikes now produced.



DOT 5

Silicone fluid as used in Harley Davidson Motorcycles and many special High Performance Brake systems.



BF307

Highly refined DOT 4 Brake fluid, ideal for Racing or High Performance Road bikes. Can be used in all systems specifying DOT 4 but **NOT** with (DOT 5) silicone fluids.

TO ORDER USE THESE PART NUMBERS

SIX PACK		SINGLE BOTTLES	
DOT 4 (Six Pack)	BF004	DOT 4 (Single)	BF004A
DOT 5 (Six Pack) (Silicone)	BF005	DOT 5 (Single) (Silicone)	BF005A
BF 307 (Six Pack)	BF307	BF 307 (Single)	BF307A

CAUTION: Please check carefully the type of brake fluid used in your system. Adding incorrect fluids could cause major brake failure. DO NOT ever mix glycol fluids (DOT 4 or BF-307) with DOT 5 silicone.

Check your owners manual to see if your system is based on Silicone or Glycol fluid.
Some pre 2005 Harley® models did use Silicone.

CLUTCH KITS AND SPRINGS

EBC Brakes CK friction plate kits contain a complete engine set of stack height controlled friction plates with a unique alloy impregnated clutch facings to prevent burn up and slippage. EBC Brakes SRC series is an aramid fiber lined friction plate set with heavy duty diaphragm springs where required. SRK series includes a full set of friction plates, steel plates and heavy duty diaphragm clutch springs where required. EBC Brakes offer CSK heavy duty clutch coil or diaphragm clutch springs kits where appropriate. EBC Brakes also offer a comprehensive list of clutch holding tools for removal and loosening of the drive shafts bolts and re-tightening a breeze without damaging your expensive clutch basket.

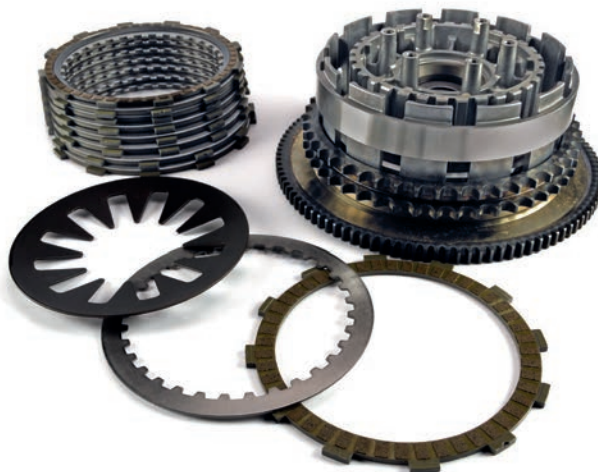

EBC BRAKES JETS

A-BAX Precision Engineering Ltd brass main jets for Keihin CVH carburettors, used on most big twins. Sold in packets of 2 pieces and in dealer assortment kits of 12 sizes (2 pieces each size).



**DEALER SELECTION KIT
PART NO – HDJK-12**

MAIN JETS



Slot Jets
for Harley
Davidson®

**424-27 slotted series
part numbers below are
for a packet of 2 jets.**



SIZES AVAILABLE

EBC424-27-165
EBC424-27-170
EBC424-27-175
EBC424-27-180
EBC424-27-185
EBC424-27-190
EBC424-27-195
EBC424-27-200
EBC424-27-205
EBC424-27-210
EBC424-27-220

PILOT JETS

Pilot Jets
for Harley Davidson®
(Sold as singles)

**Jet Style – N424-25
Pilot / Slow Running Jet
FCR 28 / 32 / 33 / 35 / 37 / 39 / 41mm
Harley® D Keihin BH (Non CV Type)**



Size Part

35	EBC424-25-35
38	EBC424-25-38
40	EBC424-25-40
42	EBC424-25-42
45	EBC424-25-45
48	EBC424-25-48
50	EBC424-25-50
52	EBC424-25-52
55	EBC424-25-55
58	EBC424-25-58
60	EBC424-25-60
62	EBC424-25-62
65	EBC424-25-65

FRONT: AMERICAN PRODUCED MOTORCYCLES



SUFFIX OR PREFIX
PAD MATERIALS AND DESCRIPTION

	YEAR	FRONT				FRONT ROTOR OPTIONS	Line #
		PADS	PADS	PADS	PADS	DESIGN NO.	
		FA	V	HH	EPFA		
HARLEY-DAVIDSON® ELECTRIC		Organic Pads	Semi-Sintered V-Pads™	Double-H™ USA-Made Sintered Pads	Premium Low Noise Street Sintered Pads	See Buyers Guide for rotor style & finish options. Part nos for ordering & sizing.	
LiveWire	2018-2023	FA630*	FA630V*	FA630HH*		017	1
S2 Del Mar	2024	FA630	FA630V	FA630HH			2
HARLEY-DAVIDSON® ADVENTURE TOURING							3
RA 1250 Pan America Adventure	2021-2024		FA630V*	FA630HH*	EPFA630HH*	MD8020*	5
RA 1250 S Pan America Adventure Special	2021-2025		FA630V*	FA630HH*	EPFA630HH*	MD8018X*	6
HARLEY-DAVIDSON® STREET							7
XG 500 Street	2014-2015	FA643	FA643V	FA643HH		MD531	9
XG 500 Street	2016-2020	FA209/2	FA209/2V	FA209/2HH	EPFA209/2HH	022	10
XG 750 Street	2014-2015	FA643	FA643V	FA643HH		MD531	11
XG 750 Street	2016-2020	FA209/2	FA209/2V	FA209/2HH	EPFA209/2HH	022	12
XG 750A Street Rod	2017-2020	FA209/2	FA209/2V	FA209/2HH	EPFA209/2HH	022	13
HARLEY-DAVIDSON® SPORTSTER							14
XLH, XLCH Rivet type	1973-1978	FA26					16
XLH 1000	1979-1981	FA71*	FA71V*				17
XLH 1000 Hayes Caliper	1984-1987	FA94	FA94V	FA94HH		002	18
XLH 1200 Hayes Caliper	1987-1999	FA94	FA94V	FA94HH		002	19
XL 53c *Oversize Rotor Available	2000-2003	FA400	FA400V	FA400HH		001	20
XL 883 Hugger *Oversize Rotor Available	2000-2003	FA400	FA400V	FA400HH		001	21
XL 883 R 100th Anniversary Edition *Oversize Rotor Available	2003	FA400*	FA400V*	FA400HH*	EPFA400HH*	001	22
XLH 883 *Oversize Rotor Available	2000-2003	FA400	FA400V	FA400HH		001	23
XL 883 R Sportster Flat Track *Oversize Rotor Available	2000-2003	FA400	FA400V	FA400HH		001	24
XL 883 C Sportster *Oversize Rotor Available	2004-2010	FA381	FA381V	FA381HH		001	25
XL 883 Hugger *Oversize Rotor Available	2004-2006	FA381	FA381V	FA381HH		001	26
XL 883 L Low *Oversize Rotor Available	2007-2010	FA381	FA381V	FA381HH		001	27
XL 883 L Superlow *Oversize Rotor Available	2011-2013	FA381	FA381V	FA381HH		001	28
XL 883 R Sportster *Oversize Rotor Available	2004-2013	FA381*	FA381V*	FA381HH*		001	29
XL 883 Sportster Standard *Oversize Rotor Available	2004-2010	FA381	FA381V	FA381HH		001	30
XL 883 N Iron *Oversize Rotor Available	2009-2013	FA381	FA381V	FA381HH		001	31
XL 883 L Superlow *Oversize Rotor Available	2014-2020	FA640	FA640V	FA640HH	EPFA640HH	010	32
XL 883 N Iron *Oversize Rotor Available	2014-2022	FA640	FA640V	FA640HH	EPFA640HH	010	33
XL 883 R Roadster *Oversize Rotor Available	2014-2015	FA640	FA640V	FA640HH	EPFA640HH	010	34
XL 1200 *Oversize Rotor Available	2000-2003	FA400	FA400V	FA400HH		001	35
XL 1200 Custom *Oversize Rotor Available	2000-2003	FA400	FA400V	FA400HH		001	36
XL 1200 S *Oversize Rotor Available	2000-2003	FA400*	FA400V*	FA400HH*	EPFA400HH*	001	37
XL 1200 *Oversize Rotor Available	2004-2010	FA381	FA381V	FA381HH		001	38
XL 1200 Custom *Oversize Rotor Available	2004-2013	FA381	FA381V	FA381HH		001	39
XL 1200 L *Oversize Rotor Available	2007-2012	FA381	FA381V	FA381HH		001	40
XL 1200 N Nightster *Oversize Rotor Available	2007-2012	FA381	FA381V	FA381HH		001	41
XL 50 Annivesary 1200 *Oversize Rotor Available	2007	FA381	FA381V	FA381HH		001	42
XL 1200 R *Oversize Rotor Available	2004-2009	FA381	FA381V	FA381HH		001	43
XL 1200 R Sportster Roadster *Oversize Rotor Available	2004-2008	FA381*	FA381V*	FA381HH*		001	44
XL 1200 V Seventy Two *Oversize Rotor Available	2011-2013	FA381	FA381V	FA381HH		001	45
XL 1200 X Forty Eight *Oversize Rotor Available	2010-2013	FA381	FA381V	FA381HH		001	46
XL 1200 C Custom *Oversize Rotor Available	2014-2020	FA640	FA640V	FA640HH	EPFA640HH	010	47
XL 1200 CX Roadster *Oversize Rotor Available	2016-2020	FA640*	FA640V*	FA640HH*	EPFA640HH*	010	48
XL 1200 NS Iron *Oversize Rotor Available	2018-2021	FA640	FA640V	FA640HH	EPFA640HH	010	49
XL 1200 T Superlow *Oversize Rotor Available	2014-2020	FA640	FA640V	FA640HH	EPFA640HH	010	50
XL 1200 V Seventy Two *Oversize Rotor Available	2014-2016	FA640	FA640V	FA640HH	EPFA640HH	010	51
XL 1200 X Forty Eight *Oversize Rotor Available	2014-2022	FA640	FA640V	FA640HH	EPFA640HH	010	52
XL 1200 XSANX Forty Eight Anniversary *Oversize Rotor Available	2018	FA640	FA640V	FA640HH	EPFA640HH	010	53
XL 1200 XS Forty Eight Special *Oversize Rotor Available	2018-2020	FA640	FA640V	FA640HH	EPFA640HH	010	54
XR 1200	2008-2010			FA296HH*	EPFA296HH*	001	55

* symbol after part# = 2 pieces required i.e. 2 pad sets or 2 rotors (twin rotor models)

*Oversize rotor available - see buyer's guide

FRONT: AMERICAN PRODUCED MOTORCYCLES



SUFFIX OR PREFIX
PAD MATERIALS AND DESCRIPTION

HARLEY-DAVIDSON® SPORTSTER

XR 1200 X 2010-2013

HARLEY-DAVIDSON® SPORTSTER RH

RH 975 Nightster 2022-2024
RH 975S Nightster Special 2023-2025
RH 1250S Sportster S 2021-2025

HARLEY-DAVIDSON® DYNA

FX, FXE Rivet type 1973-1977
FL, FLH Banana Caliper 1980-1983
FX, FXE, FXS Late 1978-1983
FXWG, FXSB 1983
FXD, FXDL, FXDWG, FXR, FXRS, FXRT, FXRD, FXLR 1982-1983
FXD/L/WG, FXR/S/T/D, FXLR Late 1987-1999 Hayes Caliper 1987-1999
FXD/L/WG, FXR/S/T/D/R 1984-Early 1987 Hayes Caliper 1984-1987
FX, FXE, FXS Hayes Caliper 1984-1986
FXDS Glide Convertible 1450 *Oversize Rotor Available 1999-2000
FXD Super Glide *Oversize Rotor Available 2000-2003
FXDL Low Rider *Oversize Rotor Available 2000-2003
FXDWG Wide Glide *Oversize Rotor Available 2000-2003
FXDX Super Glide Sport *Oversize Rotor Available 2000-2003
FXDXT Superglide T-Sport *Oversize Rotor Available 2001-2003
FXDBi Street Bob *Oversize Rotor Available 2006-2007
FXDCi Superglide Custom *Oversize Rotor Available 2005-2007
FXDi Super Glide 2006-2007
FXDi Super Glide *Oversize Rotor Available 2004-2007
FXDi Super Glide *Oversize Rotor Available 2006-2007
FXDWGi Wide Glide *Oversize Rotor Available 2004-2007
FXDXi Super Glide Sport *Oversize Rotor Available 2004-2005
FXDLi Low Rider 2006-2007
FXDLi Low Rider *Oversize Rotor Available 2004-2007
FXDWG Wide Glide *Oversize Rotor Available 2008
FXD Super Glide 2008-2010
FXD Super Glide *Oversize Rotor Available 2008-2010
FXDF Fat Bob 2008-2010
FXDL Low Rider *Oversize Rotor Available 2008-2013
FXDWG Dyna Wide Glide *Oversize Rotor Available 2008-2017
FXDB Street Bob *Oversize Rotor Available 2008-2017
FXDC Super Glide Custom 96 *Oversize Rotor Available 2008-2014
FXDF 96 Fat Bob *Oversize Rotor Available 2011-2017
FLD Switchback *Oversize Rotor Available 2012-2016
FXDBC Street Bob Limited *Oversize Rotor Available 2016
FXDL Low Rider 103 *Oversize Rotor Available 2014-2017
FXDLS Low Rider S *Oversize Rotor Available 2016-2017

*Oversize rotor available - see buyer's guide

HARLEY-DAVIDSON® SOFTAIL

FXST/B/C/S, FLST/C/F/S/N Hayes Caliper 1984-1987
FXST/B/C/S, FLST/C/F/S/N Hayes Caliper 1987-1999
FLSTS Heritage Springer Hayes Caliper *Oversize Rotor Available 2000-2003
FLSTS Springer Hayes Caliper 2000-2005
FLSTSC/FLSTSCI Springer Classic Hayes Caliper *Oversize Rotor Available 2006-2007
FLSTSB Softail Cross Bones Hayes Caliper *Oversize Rotor Available 2008-2011
FXST Softail Standard *Oversize Rotor Available 2000-2005
FXSTB Night Train *Oversize Rotor Available 2000-2005
FLSTFi Fat Boy 15th Anniversary Edition *Oversize Rotor Available 2005

FRONT					FRONT ROTOR OPTIONS	DESIGN NO.
PADS	PADS	PADS	PADS			
FA	V	HH	EPFA			
Organic Pads	Semi-Sintered V-Pads™	Double-H™ USA-Made Sintered Pads	Premium Low Noise Street Sintered Pads		See Buyers Guide for rotor style & finish options. Part nos for ordering & sizing.	
		FA296HH*	EPFA296HH*		001	
FA409	FA409V	FA409HH	EPFA409HH		MD8033X	
FA409	FA409V	FA409HH	EPFA409HH		MD8033X	
FA630	FA630V	FA630HH	EPFA630HH		MD8030	
FA26						
FA24/2	FA24/2V					
FA71	FA71V					
FA71	FA71V				002	
FA71*	FA71V*					
FA94*	FA94V*	FA94HH*	EPFA94HH*		002	
FA94*	FA94V*	FA94HH*	EPFA94HH*		002	
FA94*	FA94V*	FA94HH*	EPFA94HH*		002	
FA400*	FA400V*	FA400HH*	EPFA400HH*		001	
FA400	FA400V	FA400HH	EPFA400HH		001	
FA400*	FA400V*	FA400HH*	EPFA400HH*		001	
FA400*	FA400V*	FA400HH*	EPFA400HH*		001	
FA400*	FA400V*	FA400HH*	EPFA400HH*		001	
FA400*	FA400V*	FA400HH*	EPFA400HH*		001	
FA400*	FA400V*	FA400HH*	EPFA400HH*		001	
FA400*	FA400V*	FA400HH*	EPFA400HH*		001	
FA400	FA400V	FA400HH	EPFA400HH		001	
FA400	FA400V	FA400HH	EPFA400HH		010	
FA400	FA400V	FA400HH	EPFA400HH		001	
FA400*	FA400V*	FA400HH*	EPFA400HH*		001	
FA400	FA400V	FA400HH	EPFA400HH		006	
FA400	FA400V	FA400HH	EPFA400HH		001	
FA400	FA400V	FA400HH	EPFA400HH		010	
FA457	FA457V	FA457HH	EPFA457HH		010	
FA457	FA457V	FA457HH	EPFA457HH		006	
FA457	FA457V	FA457HH	EPFA457HH		010	
FA457*	FA457V*	FA457HH*	EPFA457HH*		017	
FA457	FA457V	FA457HH	EPFA457HH		010	
FA457	FA457V	FA457HH	EPFA457HH		010	
FA457	FA457V	FA457HH	EPFA457HH		010	
FA457*	FA457V*	FA457HH*	EPFA457HH*		010	
FA457	FA457V	FA457HH	EPFA457HH		010	
FA457*	FA457V*	FA457HH*	EPFA457HH*		010	
FA457*	FA457V*	FA457HH*	EPFA457HH*		010	
FA457*	FA457V*	FA457HH*	EPFA457HH*		010	
FA94	FA94V	FA94HH	EPFA94HH		002	
FA94	FA94V	FA94HH	EPFA94HH		002	
FA94	FA94V	FA94HH	EPFA94HH		001	
FA94	FA94V	FA94HH	EPFA94HH		002	
FA94	FA94V	FA94HH	EPFA94HH		001	
FA94	FA94V	FA94HH	EPFA94HH		001	
FA400	FA400V	FA400HH	EPFA400HH		001	
FA400	FA400V	FA400HH	EPFA400HH		001	
FA400	FA400V	FA400HH	EPFA400HH		001	

Line #
1
2
3
4
5
6
7
8
9
10
11
12
13
14
15
16
17
18
19
20
21
22
23
24
25
26
27
28
29
30
31
32
33
34
35
36
37
38
39
40
41
42
43
44
45
46
47
48
49
50
51
52
53
54
55

* symbol after part# = 2 pieces required i.e. 2 pad sets or 2 rotors (twin rotor models)

FRONT: AMERICAN PRODUCED MOTORCYCLES



SUFFIX OR PREFIX
PAD MATERIALS AND DESCRIPTION

YEAR	FRONT				FRONT ROTOR OPTIONS	Line #	
	PADS	PADS	PADS	PADS	DESIGN NO.		
	FA	V	HH	EPFA	DESIGN NO.		
	Organic Pads	Semi-Sintered V-Pads™	Double-H™ USA-Made Sintered Pads	Premium Low Noise Street Sintered Pads	See Buyers Guide for rotor style & finish options. Part nos for ordering & sizing.		
FXSTD Deuce *Oversize Rotor Available	2000-2007	FA400	FA400V	FA400HH	EPFA400HH	001	1
FLSTC Heritage Classic *Oversize Rotor Available	2000-2007	FA400	FA400V	FA400HH	EPFA400HH	001	2
FLSTF Fat Boy *Oversize Rotor Available	2000-2007	FA400	FA400V	FA400HH	EPFA400HH	001	3
FLSTNi Softail Deluxe *Oversize Rotor Available	2005-2007	FA400	FA400V	FA400HH	EPFA400HH	001	4
FXST Softail Standard *Oversize Rotor Available	2006-2007	FA400	FA400V	FA400HH	EPFA400HH	001	5
FXSTBi Night Train *Oversize Rotor Available	2006-2007	FA400	FA400V	FA400HH	EPFA400HH	001	6
FXSTC Softail Custom *Oversize Rotor Available	2007	FA400	FA400V	FA400HH	EPFA400HH	001	7
FXSTB Night Train *Oversize Rotor Available	2008-2009	FA457	FA457V	FA457HH	EPFA457HH	001	8
FXSTC Softail Custom *Oversize Rotor Available	2008-2010	FA457	FA457V	FA457HH	EPFA457HH	001	9
FXCW Rocker *Oversize Rotor Available	2008-2011	FA457	FA457V	FA457HH	EPFA457HH	001	10
FXCWC Rocker C *Oversize Rotor Available	2008-2011	FA457	FA457V	FA457HH	EPFA457HH	001	11
FLSTFB Fat Boy LO *Oversize Rotor Available	2010-2011	FA457	FA457V	FA457HH	EPFA457HH	001	12
FXS Blackline *Oversize Rotor Available	2011-2013	FA457	FA457V	FA457HH	EPFA457HH	001	13
FLSTC Heritage Softail Classic *Oversize Rotor Available	2008-2014	FA457	FA457V	FA457HH	EPFA457HH	001	14
FLSTN Softail Deluxe *Oversize Rotor Available	2008-2014	FA457	FA457V	FA457HH	EPFA457HH	001	15
FLSTF Fat Boy *Oversize Rotor Available	2008-2014	FA457	FA457V	FA457HH	EPFA457HH	001	16
FXST Softail Standard *Oversize Rotor Available	2011-2014	FA457	FA457V	FA457HH	EPFA457HH	001	17
FLS Softail Slim *Oversize Rotor Available	2012-2014	FA457	FA457V	FA457HH	EPFA457HH	001	18
FXSB Breakout 96 *Oversize Rotor Available	2013-2014	FA457	FA457V	FA457HH	EPFA457HH	001	19
FXSB Breakout 96 & 103 *Oversize Rotor Available	2015-2017			FA296HH	EPFA296HH	010	20
FXST Softail Standard 96 *Oversize Rotor Available	2014-2017			FA296HH	EPFA296HH	010	21
FLFB Fatboy 107 *Oversize Rotor Available	2018-2022			FA296HH	EPFA296HH	010	22
FLS Softail Slim 103 *Oversize Rotor Available	2015-2017			FA296HH	EPFA296HH	010	23
FLSTC Heritage Softail Classic 103 *Oversize Rotor Available	2015-2017			FA296HH	EPFA296HH	010	24
FLSTFB Fat Boy LO *Oversize Rotor Available	2015-2017			FA296HH	EPFA296HH	010	25
FLSTN Softail Deluxe 96 *Oversize Rotor Available	2015-2017			FA296HH	EPFA296HH	010	26
FLDE Deluxe 107 *Oversize Rotor Available	2018-2022			FA296HH	EPFA296HH	010	27
FLHC Heritage Classic 107 *Oversize Rotor Available	2018-2022			FA296HH	EPFA296HH	010	28
FLSB Sport Glide 107 *Oversize Rotor Available	2018-2023			FA296HH	EPFA296HH	010	29
FLSL Softail Slim 107 *Oversize Rotor Available	2018-2022			FA296HH	EPFA296HH	010	30
FLSS Softail Slim S *Oversize Rotor Available	2016-2020			FA296HH	EPFA296HH	010	31
FXBB Street Bob 107 *Oversize Rotor Available	2018-2023			FA296HH	EPFA296HH	010	32
FXBR Breakout *Oversize Rotor Available	2018-2020			FA296HH	EPFA296HH	010	33
FXFB Fat Bob - Oversize Rotor Available	2018-2020			FA296HH*	EPFA296HH*	010	34
FXFBS Fat Bob 107 & 114 *Oversize Rotor Available	2018-2024			FA296HH*	EPFA296HH*	010	35
FXLR Low Rider 107 *Oversize Rotor Available	2018-2020			FA296HH*	EPFA296HH*	010	36
FXST Softail Standard 107 *Oversize Rotor Available	2020-2025			FA296HH	EPFA296HH	010	37
FLFBS Fat Boy 114 *Oversize Rotor Available	2018-2025			FA296HH	EPFA296HH	010	38
FLFBS Fat Boy 114 Anniversary *Oversize Rotor Available	2018			FA296HH	EPFA296HH	010	39
FLHCS Heritage Classic 114 *Oversize Rotor Available	2018-2025			FA296HH	EPFA296HH	010	40
FLHCS Heritage Classic 114 Anniversary *Oversize Rotor Available	2018-2020			FA296HH	EPFA296HH	010	41
FLI Hydra-Glide Revival 114 *Oversize Rotor Available	2024-2025			FA296HH	EPFA296HH	010	42
FLSB Sport Glide *Oversize Rotor Available	2024-2025			FA296HH	EPFA296HH	010	43
FLSTF Fat Boy *Oversize Rotor Available	2015-2017			FA296HH	EPFA296HH	010	44
FLSTFBS Fat Boy S *Oversize Rotor Available	2016-2017			FA296HH	EPFA296HH	010	45
FLSTFBS Fat Boy S *Oversize Rotor Available	2016-2018			FA296HH	EPFA296HH	010	46
FXBBS Street Bob 114 *Oversize Rotor Available	2021-2025			FA296HH	EPFA296HH	010	47
FXBR Breakout 114 *Oversize Rotor Available	2018-2025			FA296HH	EPFA296HH	010	48
FXBRS Breakout 114 Anniversary *Oversize Rotor Available	2018-2020			FA296HH	EPFA296HH	010	49
FXBRS Breakout 114 Anniversary *Oversize Rotor Available	2024-2025			FA296HH	EPFA296HH	010	50
FXDR 114-FXDRS *Oversize Rotor Available	2019-2020			FA296HH*	EPFA296HH*	010	51
FXFBS Fat Bob 114 *Oversize Rotor Available	2019-2023			FA296HH*	EPFA296HH*	010	52
FXLRS Low Rider S 114 *Oversize Rotor Available	2021-2025			FA296HH*	EPFA296HH*	010	53
FXLRST Low Rider ST 117 *Oversize Rotor Available	2022-2025			FA296HH*	EPFA296HH*	010	54
FXLRST Tabacco Fade Low Rider ST 117 *Oversize Rotor Available	2024			FA296HH*	EPFA296HH*	010	55

*Oversize rotor available - see buyer's guide

* symbol after part# = 2 pieces required i.e. 2 pad sets or 2 rotors (twin rotor models)

REAR: AMERICAN PRODUCED MOTORCYCLES



Line #

HARLEY-DAVIDSON® SOFTAIL

SUFFIX OR PREFIX
PAD MATERIALS AND DESCRIPTION

YEAR

REAR					REAR ROTOR OPTIONS		
PADS	PADS	PADS	PADS		DESIGN NO.		
FA	V	HH	EPFA				
Organic Pads	Semi-Sintered V-Pads™	Double-H™ USA-Made Sintered Pads	Premium Low Noise Street Sintered Pads		See Buyers Guide for rotor style & finish options. Part nos for ordering & sizing.		
1	FXSTD Deuce	2000-2007	FA400	FA400V	FA400HH	EPFA400HH	003
2	FLSTC Heritage Classic	2000-2007	FA400	FA400V	FA400HH	EPFA400HH	003
3	FLSTF Fat Boy	2000-2007	FA400	FA400V	FA400HH	EPFA400HH	003
4	FLSTNi Softail Deluxe	2005-2007	FA400	FA400V	FA400HH	EPFA400HH	003
5	FXST Softail Standard	2006-2007	FA434	FA434V	FA434HH		003
6	FXSTBi Night Train	2006-2007	FA434	FA434V	FA434HH		003
7	FXSTC Softail Custom	2007	FA434	FA434V	FA434HH		003
8	FXSTB Night Train	2008-2009	FA458	FA458V	FA458HH	EPFA458HH	003
9	FXSTC Softail Custom	2008-2010	FA458	FA458V	FA458HH	EPFA458HH	003
10	FXCW Rocker	2008-2011	FA458	FA458V	FA458HH	EPFA458HH	003
11	FXCWC Rocker C	2008-2011	FA458	FA458V	FA458HH	EPFA458HH	003
12	FLSTFB Fat Boy LO	2010-2011	FA458	FA458V	FA458HH	EPFA458HH	003
13	FXS Blackline	2011-2013	FA458	FA458V	FA458HH	EPFA458HH	003
14	FLSTC Heritage Softail Classic	2008-2014	FA458	FA458V	FA458HH	EPFA458HH	003
15	FLSTN Softail Deluxe	2008-2014	FA458	FA458V	FA458HH	EPFA458HH	003
16	FLSTF Fat Boy	2008-2014	FA458	FA458V	FA458HH	EPFA458HH	003
17	FXST Softail Standard	2011-2014	FA458	FA458V	FA458HH	EPFA458HH	003
18	FLS Softail Slim	2012-2014	FA458	FA458V	FA458HH	EPFA458HH	003
19	FXSB Breakout 96	2013-2014	FA458	FA458V	FA458HH	EPFA458HH	003
20	FXSB Breakout 96 & 103	2015-2017		FA458V	FA458HH	EPFA458HH	003
21	FXST Softail Standard 96	2014-2017		FA710V	FA710HH	EPFA710HH	003
22	FLFB Fatboy 107	2018-2022		FA710V	FA710HH	EPFA710HH	003
23	FLS Softail Slim 103	2015-2017		FA458V	FA458HH	EPFA458HH	003
24	FLSTC Heritage Softail Classic 103	2015-2017		FA458V	FA458HH	EPFA458HH	003
25	FLSTFB Fat Boy LO	2015-2017		FA458V	FA458HH	EPFA458HH	003
26	FLSTN Softail Deluxe 96	2015-2017		FA458V	FA458HH	EPFA458HH	003
27	FLDE Deluxe 107	2018-2022		FA710V	FA710HH	EPFA710HH	003
28	FLHC Heritage Classic 107	2018-2022		FA710V	FA710HH	EPFA710HH	003
29	FLSB Sport Glide 107	2018-2023		FA710V	FA710HH	EPFA710HH	003
30	FLSL Softail Slim 107	2018-2022		FA710V	FA710HH	EPFA710HH	003
31	FLSS Softail Slim S	2016-2020		FA458V	FA458HH	EPFA458HH	003
32	FXBB Street Bob 107	2018-2023		FA710V	FA710HH	EPFA710HH	003
33	FXBR Breakout	2018-2020		FA710V	FA710HH	EPFA710HH	003
34	FXFB Fat Bob - Oversize Rotor Available	2018-2020		FA710V	FA710HH	EPFA710HH	003
35	FXFBS Fat Bob 107 & 114	2018-2024		FA710V	FA710HH	EPFA710HH	003
36	FXLR Low Rider 107	2018-2020		FA710V	FA710HH	EPFA710HH	003
37	FXST Softail Standard 107	2020-2025		FA710V	FA710HH	EPFA710HH	003
38	FLFBS Fat Boy 114	2018-2025		FA710V	FA710HH	EPFA710HH	003
39	FLFBS Fat Boy 114 Anniversary	2018		FA710V	FA710HH	EPFA710HH	003
40	FLHCS Heritage Classic 114	2018-2025		FA710V	FA710HH	EPFA710HH	003
41	FLHCS Heritage Classic 114 Anniversary	2018-2020		FA710V	FA710HH	EPFA710HH	003
42	FLI Hydra-Glide Revival 114	2024-2025		FA710V	FA710HH	EPFA710HH	003
43	FLSB Sport Glide	2024-2025		FA710V	FA710HH	EPFA710HH	003
44	FLSTF Fat Boy	2015-2017		FA458V	FA458HH	EPFA458HH	003
45	FLSTFBS Fat Boy S	2016-2017		FA458V	FA458HH	EPFA458HH	003
46	FLSTFBS Fat Boy S	2016-2018		FA458V	FA458HH	EPFA458HH	003
47	FXBBS Street Bob 114	2021-2025		FA710V	FA710HH	EPFA710HH	003
48	FXBR Breakout 114	2018-2025		FA710V	FA710HH	EPFA710HH	003
49	FXBRS Breakout 114 Anniversary	2018-2020		FA710V	FA710HH	EPFA710HH	003
50	FXBRS Breakout 114 Anniversary	2024-2025		FA710V	FA710HH	EPFA710HH	003
51	FXDR 114-FXDRS	2019-2020	FA387	FA387V	FA387HH	EPFA387HH	
52	FXFBS Fat Bob 114	2019-2023		FA710V	FA710HH	EPFA710HH	003
53	FXLRS Low Rider S 114	2021-2025		FA710V	FA710HH	EPFA710HH	003
54	FXLRST Low Rider ST 117	2022-2025		FA710V	FA710HH	EPFA710HH	003
55	FXLRST Tabacco Fade Low Rider ST 117	2024		FA710V	FA710HH	EPFA710HH	003

* symbol after part# = 2 pieces required i.e. 2 pad sets or 2 rotors (twin rotor models)

Part numbers, prefixes, suffixes, photos and illustrations shown in this catalog are trademarks and/or copyrights of EBC Brakes or the trademark owner A C Freeman Investments Ltd and use without express written permission of the owners is punishable by law.

All names & numbers are for reference purposes only. © Registered trademarks of Harley—Davidson® Motor Corp or Buell.

NOTE: — Some models may have a second rotor fitted as an optional extra. Please double check with your customer exactly which side the front rotor is fitted and if twin rotor or single.

⊗ This symbol indicates a rotor made of billet steel, and should be only used with EBC FA Organic or Vee pads.

FRONT: AMERICAN PRODUCED MOTORCYCLES



SUFFIX OR PREFIX
PAD MATERIALS AND DESCRIPTION

YEAR

FRONT					FRONT ROTOR OPTIONS	DESIGN NO.
PADS	PADS	PADS	PADS	See Buyers Guide for rotor style & finish options. Part nos for ordering & sizing.		
FA	V	HH	EPFA			
Organic Pads	Semi-Sintered V-Pads™	Double-H™ USA-Made Sintered Pads	Premium Low Noise Street Sintered Pads			
FXLRT Low Rider EL Diablo 117 *Oversize Rotor Available					010	1
HARLEY-DAVIDSON® TOURING						
FLT, FLHT, FLHTCI Ultraglide®/Electraglide®/Electraglide Classic®/Ultra Classic® Banana Caliper		FA72V*				2
FLT, FLHT, FLHTCI Ultraglide®/Electraglide®/Electraglide Classic®/Ultra Classic® Hayes Caliper	FA94*	FA94V*	FA94HH*	EPFA94HH*		3
FLT, FLHT, FLHTCI Ultraglide®/Electraglide®/Electraglide Classic®/Ultra Classic® Hayes Caliper	FA94*	FA94V*	FA94HH*	EPFA94HH*	002	4
FLT, FLHT, FLHTCI Ultraglide®/Electraglide®/Electraglide Classic®/Ultra Classic® Hayes Caliper	FA94*	FA94V*	FA94HH*	EPFA94HH*	002	5
FLHR, FLHRCi Road King®, Road King Classic® Hayes Caliper	FA94*	FA94V*	FA94HH*	EPFA94HH*	002	6
FLHR Road King *Oversize Rotor Available	FA400*	FA400V*	FA400HH*	EPFA400HH*	001	7
FLHRCi Road King Classic *Oversize Rotor Available	FA400*	FA400V*	FA400HH*	EPFA400HH*	001	8
FLHT Electra Glide Standard *Oversize Rotor Available	FA400*	FA400V*	FA400HH*	EPFA400HH*	001	9
FLHTC Electra Glide Classic *Oversize Rotor Available	FA400*	FA400V*	FA400HH*	EPFA400HH*	001	10
FLHTCU-I Electra Glide Ultra Classic *Oversize Rotor Available	FA400*	FA400V*	FA400HH*	EPFA400HH*	001	11
FLHX/FLHXi Street Glide *Oversize Rotor Available	FA400*	FA400V*	FA400HH*	EPFA400HH*	001	12
FLHRS Road King Custom *Oversize Rotor Available	FA400*	FA400V*	FA400HH*	EPFA400HH*	001	13
FLHR Road King 96 *Oversize Rotor Available	FA409*	FA409V*	FA409HH*	EPFA409HH*	010	14
FLHRC Road King Classic 96 *Oversize Rotor Available	FA409*	FA409V*	FA409HH*	EPFA409HH*	010	15
FLHT Electra Glide Standard 96 *Oversize Rotor Available	FA409*	FA409V*	FA409HH*	EPFA409HH*	010	16
FLHTC Electra Glide Classic 96 *Oversize Rotor Available	FA409*	FA409V*	FA409HH*	EPFA409HH*	010	17
FLHTCU Ultra Classic Electra Glide 96 *Oversize Rotor Available	FA409*	FA409V*	FA409HH*	EPFA409HH*	010	18
FLHX Street Glide 96 *Oversize Rotor Available	FA409*	FA409V*	FA409HH*	EPFA409HH*	010	19
FLTR Road Glide *Oversize Rotor Available	FA409*	FA409V*	FA409HH*	EPFA409HH*	010	20
FLTRX Road Glide Custom *Oversize Rotor Available	FA409*	FA409V*	FA409HH*	EPFA409HH*	010	21
FLHTK Electra Glide Ultra LTD *Oversize Rotor Available	FA409*	FA409V*	FA409HH*	EPFA409HH*	010	22
FLHRC Road King Classic 103 *Oversize Rotor Available	FA409*	FA409V*	FA409HH*	EPFA409HH*	010	23
FLHTCU Ultra Classic Electra Glide 103 *Oversize Rotor Available	FA409*	FA409V*	FA409HH*	EPFA409HH*	010	24
FLTRU Road Glide Ultra *Oversize Rotor Available	FA409*	FA409V*	FA409HH*	EPFA409HH*	010	25
FLHTC Electra Glide Classic 103 *Oversize Rotor Available	FA409*	FA409V*	FA409HH*	EPFA409HH*	010	26
FLHR Road King 103 *Oversize Rotor Available	FA409*	FA409V*	FA409HH*	EPFA409HH*	010	27
FLHTK Electra Glide Ultra Limited	FA409*	FA409V*	FA409HH*	EPFA409HH*	017	28
FLHRC Road King Classic 103	FA409*	FA409V*	FA409HH*	EPFA409HH*	017	29
FLHTCU Ultra Classic Electra Glide	FA409*	FA409V*	FA409HH*	EPFA409HH*	017	30
FLHX Street Glide	FA409*	FA409V*	FA409HH*	EPFA409HH*	017	31
FLHR Road King 107 *Oversize Rotor Available	FA409*	FA409V*	FA409HH*	EPFA409HH*	010	32
FLHR Road King	FA409*	FA409V*	FA409HH*	EPFA409HH*	017	33
FLHTCUL Ultra Classic Electra Glide Low	FA409*	FA409V*	FA409HH*	EPFA409HH*	017	34
FLHTKL Electra Glide Ultra LTD Low	FA409*	FA409V*	FA409HH*	EPFA409HH*	017	35
FLTRX Road Glide	FA409*	FA409V*	FA409HH*	EPFA409HH*	017	36
FLTRXS Road Glide Special	FA409*	FA409V*	FA409HH*	EPFA409HH*	017	37
FLTRXS Road Glide Special *Oversize Rotor Available	FA409*	FA409V*	FA409HH*	EPFA409HH*	010	38
FLHXS Street Glide Special	FA409*	FA409V*	FA409HH*	EPFA409HH*	017	39
FLTRU Road Glide Ultra	FA409*	FA409V*	FA409HH*	EPFA409HH*	017	40
FLTRXS Road Glide Special	FA409*	FA409V*	FA409HH*	EPFA409HH*	017	41
FLTRXS Road Glide Special *Oversize Rotor Available	FA409*	FA409V*	FA409HH*	EPFA409HH*	010	42
FLHRC Road King Classic 107	FA409*	FA409V*	FA409HH*	EPFA409HH*	017	43
FLHTCU Ultra Classic Electra Glide	FA409*	FA409V*	FA409HH*	EPFA409HH*	017	44
FLTRU Road Glide Ultra	FA409*	FA409V*	FA409HH*	EPFA409HH*	017	45
FLHTKL Electra Glide Ultra Limited Low	FA409*	FA409V*	FA409HH*	EPFA409HH*	017	46
FLHTK Electra Glide Ultra Limited	FA409*	FA409V*	FA409HH*	EPFA409HH*	017	47
FLHTK Electra Glide Ultra Limited	FA409*	FA409V*	FA409HH*	EPFA409HH*	017	48
FLHTK Electra Glide Ultra Limited Shrine Edition	FA409*	FA409V*	FA409HH*	EPFA409HH*	017	49
FLHX Street Glide	FA409*	FA409V*	FA409HH*	EPFA409HH*	017	50
FLHRXS Road King Special 114 *Oversize Rotor Available	FA409*	FA409V*	FA409HH*	EPFA409HH*	010	51
FLHRXS Road King Special 114	FA409*	FA409V*	FA409HH*	EPFA409HH*	017	52
FLHXS Street Glide Special *Oversize Rotor Available	FA409*	FA409V*	FA409HH*	EPFA409HH*	010	53
	FA409*	FA409V*	FA409HH*	EPFA409HH*	010	54
	FA409*	FA409V*	FA409HH*	EPFA409HH*	010	55

*Oversize rotor available - see buyer's guide

* symbol after part# = 2 pieces required i.e. 2 pad sets or 2 rotors (twin rotor models)

FRONT: AMERICAN PRODUCED MOTORCYCLES



SUFFIX OR PREFIX
PAD MATERIALS AND DESCRIPTION

		FRONT				FRONT ROTOR OPTIONS		
		PADS	PADS	PADS	PADS	DESIGN NO.		
		FA	V	HH	EPFA			
		Organic Pads	Semi-Sintered V-Pads™	Double-H™ USA-Made Sintered Pads	Premium Low Noise Street Sintered Pads		See Buyers Guide for rotor style & finish options. Part nos for ordering & sizing.	
YEAR							Line #	
HARLEY-DAVIDSON® TOURING								
	FLHXSANV Street Glide Special Anniversary *Oversize Rotor Available	2018	FA409*	FA409V*	FA409HH*	EPFA409HH*	010	1
	FLTRXS Road Glide Special 114 *Oversize Rotor Available	2019-2023	FA409*	FA409V*	FA409HH*	EPFA409HH*	010	2
	FLTRXS Road Glide Special 114	2019-2023	FA409*	FA409V*	FA409HH*	EPFA409HH*	017	3
	FLTRK Road Glide Limited	2020	FA409*	FA409V*	FA409HH*	EPFA409HH*	017	4
	FLHT Electra Glide Standard	2020-2022	FA409*	FA409V*	FA409HH*	EPFA409HH*	017	5
	FLTRK Road Glide Limited 114	2020-2024	FA409*	FA409V*	FA409HH*	EPFA409HH*	017	6
	FLH Revival 107	2021	FA409*	FA409V*	FA409HH*	EPFA409HH*	017	7
	FLH Revival 107 *Oversize Rotor Available	2021	FA409*	FA409V*	FA409HH*	EPFA409HH*	010	8
	FLHXST Street Glide Special ST 114	2022	FA409*	FA409V*	FA409HH*	EPFA409HH*	017	9
	FLTRXST Road Glide Special ST 114	2022	FA409*	FA409V*	FA409HH*	EPFA409HH*	017	10
	FLHXST Street Glide ST 107	2023	FA409*	FA409V*	FA409HH*	EPFA409HH*	017	11
	FLHXST Street Glide ST 117	2023	FA409*	FA409V*	FA409HH*	EPFA409HH*	MD8020	12
	FLTRXST Road Glide ST 117	2023	FA409*	FA409V*	FA409HH*	EPFA409HH*	MD8020	13
	FLHTK Electra Glide Tabacco Fade Ultra LTD 114	2024	FA409*	FA409V*	FA409HH*	EPFA409HH*	MD8020	14
	FLHTK Electra Glide Ultra LTD 114	2024	FA409*	FA409V*	FA409HH*	EPFA409HH*	017	15
	FLHX Street Glide 117	2024-2025	FA409*	FA409V*	FA409HH*	EPFA409HH*	MD8020	16
	FLTRX Road Glide 117	2024-2025	FA409*	FA409V*	FA409HH*	EPFA409HH*	MD8020	17
								18
								19
HARLEY-DAVIDSON® TRIKE								
	FLHTCUTG Tri Glide Ultra Classic Trike	2009-2013	FA409*	FA409V*	FA409HH*	EPFA409HH*	010	20
	FLHXXX Street Glide Trike	2010-2013	FA409*	FA409V*	FA409HH*	EPFA409HH*	010	21
	FLHTCUTG Tri Glide Ultra	2014-2019		FA638V*	FA638HH*		010	22
	FLRT Freewheeler Trike	2015-2019		FA638V*	FA638HH*		010	23
	FLHTCUTG Tri Glide Ultra	2020-2025		FA638V*	FA638HH*		010	24
	FLRT Freewheeler Trike	2020-2025		FA638V*	FA638HH*		010	25
	FLRT Road Glide 3 Trike 114	2024-2025	FA409*	FA409V*	FA409HH*	EPFA409HH*	010	26
	FLHTCUTG Tabacco Fade Tri Glide Ultra 114	2024-2025		FA638V*	FA638HH*		010	27
								28
								29
HARLEY-DAVIDSON® CVO								
	FLTRUSE 1TAN CVO Road Glide Ultra	2016	FA409*	FA409V*	FA409HH*	EPFA409HH*	017	30
	FXSE 1TG9 CVO Pro Street Breakout	2016			FA296HH*	EPFA296HH*	017	31
	FLHTKSE CVO Limited	2016	FA409*	FA409V*	FA409HH*	EPFA409HH*	017	32
	FLHXSE CVO Street Glide	2016	FA409*	FA409V*	FA409HH*	EPFA409HH*	017	33
	FLHTKSE ANV CVO Ultra Limited 117 *Oversize Rotor Available	2018	FA409*	FA409V*	FA409HH*	EPFA409HH*	010	34
	FLHTKSE ANV CVO Ultra Limited Anniversary 117 *Oversize Rotor Available	2018	FA409*	FA409V*	FA409HH*	EPFA409HH*	010	35
	FLHXSE CVO Street Glide *Oversize Rotor Available	2018-2019	FA409*	FA409V*	FA409HH*	EPFA409HH*	010	36
	FLHTCUTGSE Tri Glide CVO 117 *Oversize Rotor Available	2020	FA409*	FA409V*	FA409HH*	EPFA409HH*	010	37
	FLHTKSE Ultra Limited CVO 117 *Oversize Rotor Available	2020	FA409*	FA409V*	FA409HH*	EPFA409HH*	010	38
	FLHXSE Street Glide CVO 117 *Oversize Rotor Available	2020	FA409*	FA409V*	FA409HH*	EPFA409HH*	010	39
	FLTRXSE CVO Road Glide 117 *Oversize Rotor Available	2018-2023	FA409*	FA409V*	FA409HH*	EPFA409HH*	010	40
	FLHTCUTGSE CVO Tri Glide	2021-2023	FA409*	FA409V*	FA409HH*	EPFA409HH*	010	41
	FLHTKSE CVO Ultra Limited	2021-2023	FA409*	FA409V*	FA409HH*	EPFA409HH*	017	42
	FLHXSE CVO Street Glide	2021-2022	FA409*	FA409V*	FA409HH*	EPFA409HH*	017	43
	FLHXSE CVO Street Glide	2022	FA409*	FA409V*	FA409HH*	EPFA409HH*	017	44
	FLTRKSE CVO Road Glide Limited	2022-2023	FA409*	FA409V*	FA409HH*	EPFA409HH*	017	45
	FLHXSE CVO Street Glide 121	2024-2025	FA630	FA630V*	FA630HH*	EPFA630HH*	MD8018X*	46
	FLTRXSE CVO Road Glide 121	2024-2025	FA630	FA630V*	FA630HH*	EPFA630HH*	MD8018X*	47
	FLTRXSTSE Road Glide ST CVO 121	2024-2025	FA630	FA630V*	FA630HH*	EPFA630HH*	MD8018X*	48
	RA 1250SE Pan America CVO	2024-2025	FA630	FA630V*	FA630HH*	EPFA630HH*	MD8018X*	49
								50
HARLEY-DAVIDSON® V-ROD								
	VRSCA	2002-2005	FA400*	FA400V*	FA400HH*	EPFA400HH*	006	52
	VRSCB	2004-2005	FA400*	FA400V*	FA400HH*	EPFA400HH*	006	53
	VRSCA *Oversize Rotor Available	2006	FA409*	FA409V*	FA409HH*	EPFA409HH*	007	54
	VRSCAW *Oversize Rotor Available	2007	FA409*	FA409V*	FA409HH*	EPFA409HH*	007	55

* symbol after part# = 2 pieces required i.e. 2 pad sets or 2 rotors (twin rotor models)

*Oversize rotor available - see buyer's guide

REAR: AMERICAN PRODUCED MOTORCYCLES



Line #

HARLEY-DAVIDSON® TOURING

SUFFIX OR PREFIX
PAD MATERIALS AND DESCRIPTION

YEAR

REAR

PADS

PADS

PADS

PADS

REAR ROTOR
OPTIONS

FA

V

HH

EPFA

DESIGN NO.

Organic
Pads

Semi-Sintered
V-Pads™

Double-H™
USA-Made
Sintered Pads

Premium Low
Noise Street
Sintered Pads

See Buyers Guide for
rotor style & finish
options. Part nos for
ordering & sizing.

1	FLHXSANV Street Glide Special Anniversary	2018	FA409	FA409V	FA409HH	EPFA409HH	009
2	FLTRXS Road Glide Special 114	2019-2023	FA409	FA409V	FA409HH	EPFA409HH	009
3	FLTRXS Road Glide Special 114	2019-2023	FA409	FA409V	FA409HH	EPFA409HH	009
4	FLTRK Road Glide Limited	2020	FA409	FA409V	FA409HH	EPFA409HH	009
5	FLHT Electra Glide Standard	2020-2022	FA409	FA409V	FA409HH	EPFA409HH	009
6	FLTRK Road Glide Limited 114	2020-2024	FA409	FA409V	FA409HH	EPFA409HH	009
7	FLH Revival 107	2021	FA409	FA409V	FA409HH	EPFA409HH	009
8	FLH Revival 107	2021	FA409	FA409V	FA409HH	EPFA409HH	009
9	FLHXST Street Glide Special ST 114	2022	FA409	FA409V	FA409HH	EPFA409HH	009
10	FLTRXST Road Glide Special ST 114	2022	FA409	FA409V	FA409HH	EPFA409HH	009
11	FLHXST Street Glide ST 107	2023	FA409	FA409V	FA409HH	EPFA409HH	009
12	FLHXST Street Glide ST 117	2023	FA409	FA409V	FA409HH	EPFA409HH	009
13	FLTRXST Road Glide ST 117	2023	FA409	FA409V	FA409HH	EPFA409HH	009
14	FLHTK Electra Glide Tabacco Fade Ultra LTD 114	2024	FA409	FA409V	FA409HH	EPFA409HH	009
15	FLHTK Electra Glide Ultra LTD 114	2024	FA409	FA409V	FA409HH	EPFA409HH	009
16	FLHX Street Glide 117	2024-2025	FA409	FA409V	FA409HH	EPFA409HH	009
17	FLTRX Road Glide 117	2024-2025	FA409	FA409V	FA409HH	EPFA409HH	009

HARLEY-DAVIDSON® TRIKE

▲ PADS ARE SOLD IN AXLE SETS – 4 PADS PER SET

20	FLHTCUTG Tri Glide Ultra Classic Trike	2009-2013		FA605/4V ▲	FA605/4HH ▲		MD540
21	FLHXXX Street Glide Trike	2010-2013		FA605/4V ▲	FA605/4HH ▲		MD540
22	FLHTCUTG Tri Glide Ultra	2014-2019		FA641/4V ▲	FA641/4HH ▲		MD538
23	FLRT Freewheeler Trike	2015-2019		FA641/4V ▲	FA641/4HH ▲		MD538
24	FLHTCUTG Tri Glide Ultra	2020-2025	FA631	FA631V	FA631HH		MD538
25	FLRT Freewheeler Trike	2020-2025	FA631	FA631V	FA631HH		MD538
26	FLRT Road Glide 3 Trike 114	2024-2025	FA631	FA631V	FA631HH		MD538
27	FLHTCUTG Tabacco Fade Tri Glide Ultra 114	2024-2025	FA631	FA631V	FA631HH		MD538

HARLEY-DAVIDSON® CVO

30	FLTRUSE 1TAN CVO Road Glide Ultra	2016	FA409	FA409V	FA409HH	EPFA409HH	009
31	FXSE 1TG9 CVO Pro Street Breakout	2016	FA458	FA458V	FA458HH	EPFA458HH	009
32	FLHTKSE CVO Limited	2016	FA409	FA409V	FA409HH	EPFA409HH	009
33	FLHXSE CVO Street Glide	2016	FA409	FA409V	FA409HH	EPFA409HH	009
34	FLHTKSE ANV CVO Ultra Limited 117	2018	FA409	FA409V	FA409HH	EPFA409HH	009
35	FLHTKSE ANV CVO Ultra Limited Anniversary 117	2018	FA409	FA409V	FA409HH	EPFA409HH	009
36	FLHXSE CVO Street Glide	2018-2019	FA409	FA409V	FA409HH	EPFA409HH	009
37	FLHTCUTGSE Tri Glide CVO 117	2020	FA631	FA631V	FA631HH	EPFA631HH	009
38	FLHTKSE Ultra Limited CVO 117	2020	FA409	FA409V	FA409HH	EPFA409HH	009
39	FLHXSE Street Glide CVO 117	2020	FA409	FA409V	FA409HH	EPFA409HH	009
40	FLTRXSE CVO Road Glide 117	2018-2023	FA409	FA409V	FA409HH	EPFA409HH	009
41	FLHTCUTGSE CVO Tri Glide	2021-2023	FA631	FA631V	FA631HH		MD538
42	FLHTKSE CVO Ultra Limited	2021-2023	FA409	FA409V	FA409HH	EPFA409HH	009
43	FLHXSE CVO Street Glide	2021-2022	FA409	FA409V	FA409HH	EPFA409HH	009
44	FLHXSE CVO Street Glide	2022	FA409	FA409V	FA409HH	EPFA409HH	009
45	FLTRKSE CVO Road Glide Limited	2022-2023	FA409	FA409V	FA409HH	EPFA409HH	009
46	FLHXSE CVO Street Glide 121	2024-2025	FA409	FA409V	FA409HH	EPFA409HH	009
47	FLTRXSE CVO Road Glide 121	2024-2025	FA409	FA409V	FA409HH	EPFA409HH	009
48	FLTRXSTSE Road Glide ST CVO 121	2024-2025	FA409	FA409V	FA409HH	EPFA409HH	009
49	RA 1250SE Pan America CVO	2024-2025	2024	FA213	FA213V	FA213HH	

HARLEY-DAVIDSON® V-ROD

52	VRSCA	2002-2005					
53	VRSCB	2004-2005					
54	VRSCA	2006	FA409	FA409V	FA409HH	EPFA409HH	008
55	VRSCAW	2007	FA409	FA409V	FA409HH	EPFA409HH	008

* symbol after part# = 2 pieces required i.e. 2 pad sets or 2 rotors (twin rotor models)

Part numbers, prefixes, suffixes, photos and illustrations shown in this catalog are trademarks and/or copyrights of EBC Brakes or the trademark owner A C Freeman Investments Ltd and use without express written permission of the owners is punishable by law.

All names & numbers are for reference purposes only. © Registered trademarks of Harley—Davidson® Motor Corp or Buell. NOTE: — Some models may have a second rotor fitted as an optional extra. Please double check with your customer exactly which side the front rotor is fitted and if twin rotor or single.

FRONT: AMERICAN PRODUCED MOTORCYCLES



SUFFIX OR PREFIX
PAD MATERIALS AND DESCRIPTION

HARLEY-DAVIDSON® V-ROD

YEAR	FRONT				FRONT ROTOR OPTIONS	
	FA	V	HH	EPFA	DESIGN NO.	
VRSCAW *Oversize Rotor Available	2007	FA409*	FA409V*	FA409HH*	EPFA409HH*	010
VRSCAW *Oversize Rotor Available	2008-2010	FA409*	FA409V*	FA409HH*	EPFA409HH*	010
VRSCD Night Rod *Oversize Rotor Available	2006-2008	FA409*	FA409V*	FA409HH*	EPFA409HH*	007
VRSCDX Night Rod Special Ann *Oversize Rotor Available	2012	FA409*	FA409V*	FA409HH*	EPFA409HH*	007
VRSCDX Night Rod Special inc 105 model *Oversize Rotor Available	2007-2017	FA409*	FA409V*	FA409HH*	EPFA409HH*	007
VRSCF Muscle inc 105 model *Oversize Rotor Available	2009-2017	FA409*	FA409V*	FA409HH*	EPFA409HH*	007
VRSCR Street Rod *Oversize Rotor Available	2006-2007	FA409*	FA409V*	FA409HH*	EPFA409HH*	007
VRSCX Screaming Eagle V-Rod	2007	FA409*	FA409V*	FA409HH*	EPFA409HH*	007

ARCH

1 S	2019-2022	FA175*		FA175HH*		
KRGT-1	2019-2021	FA175*		FA175HH*		
Method 143	2019-2021	FA175*		FA175HH*		

ATK

All models	up to 1992	FA126X				
All models	1993-1996	FA135X		FA135R		
All models	1997-1999	FA181X		FA181R	EPFA181HH	
125	2003	FA181X		FA181R	EPFA181HH	
250	2004	FA181X		FA181R		MD6032D
GT 250 R V-Twin Sport	2011	FA86*		FA86HH*		MD690*
GV 250 V-Twin Cruiser	2011	FA86		FA86HH		
250/260	2003	FA181X		FA181R	EPFA181HH	
370	2004	FA181X		FA181R		MD6032D
450 Enduro	2007	FA181X		FA181R	EPFA181HH	
450 Motard	2007	FA95		FA95HH	EPFA95HH	
450 MX/XC	2007	FA181X		FA181R	EPFA181HH	
500/500 Enduro	2003-2004	FA181X		FA181R	EPFA181HH	MD6032D
560	1984-1986	FA47X				
560	1987-1988	FA47X				
560	1989-1992	FA126X				
600 DTM Dirt Track Motard	2003	FA95		FA95HH	EPFA95HH	
500/600 Super Motard	2002-2003	FA95		FA95HH	EPFA95HH	
605 Enduro	2003	FA181X		FA181R	EPFA181HH	
620 Intimidator	2004	FA181X		FA181R		MD6032D
650 GT R V-Twin Sport	2011	FA86*		FA86HH*		MD690*
650 GV V-Twin Cruiser	2011	FA86*		FA86HH*		MD691*
700 Intimidator	2004-2005	FA181X		FA181R		MD6032D

BUELL

Blast	2000-2007	FA196	FA196V	FA196HH		MD737
Firebolt XB9R	2002-2006			FA345HH	EPFA345HH	MD735RS
S1 Lightning	1994-1997	FA210	FA210V			MD719RS
S1 Lightning	1998-2000	FA424		FA424HH		MD719RS
S1 White Lightning AE	1998-2000	FA424		FA424HH		MD719RS
X1 Lightning AE	1998-2000	FA424		FA424HH		MD719RS
X1 Lightning AE	2000-2005	FA424		FA424HH		MD734RS
1125 RR/CR R	2008-2010			FA454/4HH		MD735RS
M2 Cyclone	1994-1997	FA210	FA210V			MD719RS
M2 Cyclone	1998-2000	FA424		FA424HH		MD719RS
M2 Cyclone AE	2000-2005	FA424		FA424HH		MD734RS
S2 Thunderbolt	1994-1997	FA210	FA210V			MD719RS
S3 Thunderbolt AE	1998-2000	FA424		FA424HH		MD719RS
XB12 R Firebolt	2004-2007			FA345HH	EPFA345HH	MD735RS
XB12 R Firebolt	2009-2009			FA454/4HH		MD735RS

* symbol after part# = 2 pieces required i.e. 2 pad sets or 2 rotors (twin rotor models)

REAR: AMERICAN PRODUCED MOTORCYCLES



Line #

HARLEY-DAVIDSON® V-ROD

SUFFIX OR PREFIX
PAD MATERIALS AND DESCRIPTION

YEAR

REAR					REAR ROTOR OPTIONS		
PADS	PADS	PADS	PADS		DESIGN NO.		
FA	V	HH	EPFA		DESIGN NO.		
Organic Pads	Semi-Sintered V-Pads™	Double-H™ USA-Made Sintered Pads	Premium Low Noise Street Sintered Pads		See Buyers Guide for rotor style & finish options. Part nos for ordering & sizing.		
1	VRSCAW	2007	FA409	FA409V	FA409HH	EPFA409HH	008
2	VRSCAW	2008-2010	FA409	FA409V	FA409HH	EPFA409HH	008
3	VRSCD Night Rod	2006-2008	FA409	FA409V	FA409HH	EPFA409HH	008
4	VRSCDX Night Rod Special Ann	2012	FA409	FA409V	FA409HH	EPFA409HH	008
5	VRSCDX Night Rod Special inc 105 model	2007-2017	FA409	FA409V	FA409HH	EPFA409HH	008
6	VRSCF Muscle inc 105 model	2009-2017	FA409	FA409V	FA409HH	EPFA409HH	014
7	VRSCR Street Rod	2006-2007	FA409	FA409V	FA409HH	EPFA409HH	008
8	VRSCX Screaming Eagle V-Rod	2007	FA409	FA409V	FA409HH	EPFA409HH	008
9							
10	ARCH						
11	1 S	2019-2022	FA47		FA47HH		
12	KRGT-1	2019-2021	FA47		FA47HH		
13	Method 143	2019-2021	FA47		FA47HH		
14							
15	ATK						
16	All models	up to 1992	FA47X		FA47R		
17	All models	1993-1996	FA135X		FA135R		
18	All models	1997-1999	FA208X		FA208R		
19	125	2003	FA208X		FA208R		
20	250	2004	FA208X		FA208R		MD6035D
21	GT 250 R V-Twin Sport	2011	FA86		FA86HH		MD689
22	GV 250 V-Twin Cruiser	2011	606		606G		
23	250/260	2003	FA208X		FA208R		
24	370	2004	FA208X		FA208R		MD6035D
25	450 Enduro	2007	FA208X		FA208R		
26	450 Motard	2007	FA131X		FA131R		
27	450 MX/XC	2007	FA208X		FA208R		
28	500/500 Enduro	2003-2004	FA208X		FA208R		MD6035D
29	560	1984-1986			814G		
30	560	1987-1988	FA115X		FA115R		
31	560	1989-1992	FA115X		FA115R		
32	600 DTM Dirt Track Motard	2003	FA208X		FA208R		
33	500/600 Super Motard	2002-2003	FA208X		FA208R		
34	605 Enduro	2003	FA208X		FA208R		
35	620 Intimidator	2004	FA208X		FA208R		MD6035D
36	650 GT R V-Twin Sport	2011	FA86		FA86HH		MD689
37	650 GV V-Twin Cruiser	2011	FA86		FA86HH		
38	700 Intimidator	2004-2005	FA208X		FA208R		MD6035D
39							
40	BUELL						
41	Blast	2000-2007	FA140	FA140V	FA140HH		MD738
42	Firebolt XB9R	2002-2006	FA140	FA140V	FA140HH		MD511
43	S1 Lightning	1994-1997	FA251				MD511
44	S1 Lightning	1998-2000	FA251				MD511
45	S1 White Lightning AE	1998-2000	FA140	FA140V	FA140HH		MD511
46	X1 Lightning AE	1998-2000	FA140	FA140V	FA140HH		MD511
47	X1 Lightning AE	2000-2005	FA140	FA140V	FA140HH		MD511
48	1125 RR/CR R	2008-2010			FA460HH		
49	M2 Cyclone	1994-1997	FA251				MD511
50	M2 Cyclone	1998-2000	FA251				MD511
51	M2 Cyclone AE	2000-2005	FA140	FA140V	FA140HH		MD511
52	S2 Thunderbolt	1994-1997	FA251				MD511
53	S3 Thunderbolt AE	1998-2000	FA140	FA140V	FA140HH		MD511
54	XB12 R Firebolt	2004-2007	FA140	FA140V	FA140HH		MD522
55	XB12 R Firebolt	2009-2009	FA140	FA140V	FA140HH		MD522

All names & numbers are for reference purposes only. © Registered trademarks of Harley—Davidson® Motor Corp or Buell.

NOTE: — Some models may have a second rotor fitted as an optional extra. Please double check with your customer exactly which side the front rotor is fitted and if twin rotor or single.

* symbol after part# = 2 pieces required i.e. 2 pad sets or 2 rotors (twin rotor models)

Part numbers, prefixes, suffixes, photos and illustrations shown in this catalog are trademarks and/or copyrights of EBC Brakes or the trademark owner A C Freeman Investments Ltd and use without express written permission of the owners is punishable by law.

FRONT: AMERICAN PRODUCED MOTORCYCLES



SUFFIX OR PREFIX
PAD MATERIALS AND DESCRIPTION

		FRONT						
		PADS	PADS	PADS	PADS	FRONT ROTOR OPTIONS		
		FA	V	HH	EPFA	DESIGN NO.		
		Organic Pads	Semi-Sintered V-Pads™	Double-H™ USA-Made Sintered Pads	Premium Low Noise Street Sintered Pads	See Buyers Guide for rotor style & finish options. Part nos for ordering & sizing.		
YEAR								
BUELL								
XB12 S Ulysses	2006-2009			FA345HH	EPFA345HH	MD735RS	1	
XB12 SCG Lightning	2006-2008			FA345HH	EPFA345HH	MD735RS	2	
XB12 Ss Lightning	2009-2009			FA454/4HH		MD735RS	3	
XB12 Ss Lightning Long	2006-2008			FA345HH	EPFA345HH	MD735RS	4	
XB12 STT Lightning	2009-2009			FA454/4HH		MD735RS	5	
XB12 XT Ulysses	2008-2009			FA345HH	EPFA345HH	MD735RS	6	
XB9S Lightning	2003-2004			FA345HH	EPFA345HH	MD735RS	7	
XB9SX Lightning	2004-2009			FA345HH	EPFA345HH	MD735RS	8	
XB9SX Lightning City X	2005-2008			FA345HH	EPFA345HH	MD735RS	9	
CAN-AM CANYON							10	
Canyon	2025	FA630	FA630V	FA630HH	EPFA630HH	MD853	11	
Canyon Redrock	2025	FA630	FA630V	FA630HH	EPFA630HH	MD853	13	
Canyon XT	2025	FA630	FA630V	FA630HH	EPFA630HH	MD853	14	
CAN-AM RYKER							15	
600 Ace	Left	2018-2025	FA165X*	FA165R*			17	
600 Ace	Right	2018-2025	FA135X*	FA135R*			18	
900 Ace Rally Edition	Left	2021-2025	FA165X*	FA165R*			19	
900 Ace Rally Edition	Right	2021-2025	FA135X*	FA135R*			20	
900 Ace	Left	2018-2025	FA165X*	FA165R*			21	
900 Ace	Right	2018-2025	FA135X*	FA135R*			22	
Ryker Sport	Left	2025	FA165X*	FA165R*			23	
Ryker Sport	Right	2025	FA135X*	FA135R*			24	
CAN-AM SPYDER							25	
F3 SE6/SM6		2015-2025		FA630V*	FA630HH*	EPFA630HH*	MD853*	27
F3 LTD Inc Special Series		2016-2025		FA630V*	FA630HH*	EPFA630HH*	MD853*	28
F3-S SE6/SM6 Inc Special Series		2016-2025		FA630V*	FA630HH*	EPFA630HH*	MD853*	29
F3-S Daytona 500		2017		FA630V*	FA630HH*	EPFA630HH*	MD853*	30
F3-T		2016-2025		FA630V*	FA630HH*	EPFA630HH*	MD853*	31
RS		2010-2012	FA474*	FA474V*			MD801*	32
RS		2013-2016		FA630V*	FA630HH*	EPFA630HH*	MD853*	33
RS SE5/SM5 Inc Phantom Black model		2008-2009	FA474*	FA474V*			MD801*	34
RS-S		2010-2012	FA474*	FA474V*			MD801*	35
RS-S		2013-2016		FA630V*	FA630HH*	EPFA630HH*	MD853*	36
RT		2010-2012	FA474*	FA474V*			MD801*	37
RT		2013-2024		FA630V*	FA630HH*	EPFA630HH*	MD853*	38
RT LTD		2010-2012	FA474*	FA474V*			MD801*	39
RT LTD		2013-2024		FA630V*	FA630HH*	EPFA630HH*	MD853*	40
RT-S Special Series		2016-2017		FA630V*	FA630HH*	EPFA630HH*	MD853*	41
RT-S		2010-2012	FA474*	FA474V*			MD801*	42
RT-S		2013-2015		FA630V*	FA630HH*	EPFA630HH*	MD853*	43
ST inc ST LTD model		2013-2016		FA630V*	FA630HH*	EPFA630HH*	MD853*	44
ST-S		2013-2016		FA630V*	FA630HH*	EPFA630HH*	MD853*	45
EBR							46	
1190 RS Sport		2014-2015			FA454/4HH		MD735RS	48
1190 RX Sport		2014-2015			FA454/4HH		MD735RS	49
1190 SX		2014-2015			FA454/4HH		MD735RS	50
INDIAN							51	
Scout Rogue Sixty		2023-2024	FA209/2	FA209/2V	FA209/2HH		MD534	53
Scout Sixty		2016	FA672	FA672V	FA672HH		MD534	54
Scout Sixty		2017-2024	FA209/2	FA209/2V	FA209/2HH		MD534	55

* symbol after part# = 2 pieces required i.e. 2 pad sets or 2 rotors (twin rotor models)

REAR: AMERICAN PRODUCED MOTORCYCLES



Line #

BUELL

SUFFIX OR PREFIX
PAD MATERIALS AND DESCRIPTION

YEAR

REAR

PADS

PADS

PADS

PADS

REAR ROTOR
OPTIONS

FA

V

HH

EPFA

DESIGN NO.

Organic
Pads

Semi-Sintered
V-Pads™

Double-H™
USA-Made
Sintered Pads

Premium Low
Noise Street
Sintered Pads

See Buyers Guide for
rotor style & finish
options. Part nos for
ordering & sizing.

1	XB12 S Ulysses		2006-2009	FA140	FA140V	FA140HH		MD522
2	XB12 SCG Lightning		2006-2008	FA140	FA140V	FA140HH		MD522
3	XB12 Ss Lightning		2009-2009	FA140	FA140V	FA140HH		MD522
4	XB12 Ss Lightning Long		2006-2008	FA140	FA140V	FA140HH		MD522
5	XB12 STT Lightning		2009-2009	FA140	FA140V	FA140HH		MD522
6	XB12 XT Ulysses		2008-2009	FA140	FA140V	FA140HH		MD522
7	XB9S Lightning		2003-2003	FA140	FA140V	FA140HH		MD522
8	XB9SX Lightning		2004-2009	FA140	FA140V	FA140HH		MD522
9	XB9SX Lightning City X		2005-2008	FA140	FA140V	FA140HH		MD522

CAN-AM CANYON

10								
11								
12	Canyon		2025	FA631	FA631V	FA631HH		MD854
13	Canyon Redrock		2025	FA631	FA631V	FA631HH		MD854
14	Canyon XT		2025	FA631	FA631V	FA631HH		MD854

CAN-AM RYKER

15								
16								
17	600 Ace	Left	2018-2025	FA317X		FA317R		
18	600 Ace	Right	2018-2025					
19	900 Ace Rally Edition	Left	2021-2025	FA317X		FA317R		
20	900 Ace Rally Edition	Right	2021-2025					
21	900 Ace	Left	2018-2025	FA317X		FA317R		
22	900 Ace	Right	2018-2025					
23	Ryker Sport	Left	2025	FA317X		FA317R		
24	Ryker Sport	Right	2025					

CAN-AM SPYDER

25								
26								
27	F3 SE6/SM6		2015-2025		FA631V	FA631HH		MD854
28	F3 LTD Inc Special Series		2016-2025		FA631V	FA631HH		MD854
29	F3-S SE6/SM6 Inc Special Series		2016-2025		FA631V	FA631HH		MD854
30	F3-S Daytona 500		2017			FA631HH		MD854
31	F3-T		2016-2025			FA631HH		MD854
32	RS		2010-2012	FA473	FA473V			MD802
33	RS		2013-2016			FA631HH		MD854
34	RS SE5/SM5 Inc Phantom Black model		2008-2009	FA473	FA473V			MD802
35	RS-S		2010-2012	FA473	FA473V			MD802
36	RS-S		2013-2016			FA631HH		MD854
37	RT		2010-2012	FA473	FA473V			MD802
38	RT		2013-2021			FA631HH		MD854
39	RT LTD		2010-2012	FA473	FA473V			MD802
40	RT LTD		2013-2021			FA631HH		MD854
41	RT-S Special Series		2016-2017			FA631HH		MD854
42	RT-S		2010-2012	FA473	FA473V			MD802
43	RT-S		2013-2015			FA631HH		MD854
44	ST inc ST LTD model		2013-2016			FA631HH		MD854
45	ST-S		2013-2016			FA631HH		MD854

EBR

46								
47								
48	1190 RS Sport		2014-2015			FA460HH		
49	1190 RX Sport		2014-2015			FA460HH		
50	1190 SX		2014-2015			FA460HH		

INDIAN

51								
52								
53	Scout Rogue Sixty		2023-2024	FA213		FA213HH		MD534
54	Scout Sixty		2016	FA377X	FA377V			MD534
55	Scout Sixty		2017-2024	FA213		FA213HH		MD534

* symbol after part# = 2 pieces required i.e. 2 pad sets or 2 rotors (twin rotor models)

Part numbers, prefixes, suffixes, photos and illustrations shown in this catalog are trademarks and/or copyrights of EBC Brakes or the trademark owner A C Freeman Investments Ltd and use without express written permission of the owners is punishable by law.

All names & numbers are for reference purposes only. © Registered trademarks of Harley—Davidson® Motor Corp or Buell. NOTE: — Some models may have a second rotor fitted as an optional extra. Please double check with your customer exactly which side the front rotor is fitted and if twin rotor or single.

FRONT: AMERICAN PRODUCED MOTORCYCLES



SUFFIX OR PREFIX
PAD MATERIALS AND DESCRIPTION

	YEAR	FRONT					FRONT ROTOR OPTIONS DESIGN NO.	Line #
		PADS	PADS	PADS	PADS			
		FA	V	HH	EPFA			
INDIAN		Organic Pads	Semi-Sintered V-Pads™	Double-H™ USA-Made Sintered Pads	Premium Low Noise Street Sintered Pads		See Buyers Guide for rotor style & finish options. Part nos for ordering & sizing.	
Scout Bobber Sixty	2021-2024	FA209/2	FA209/2V	FA209/2HH				1
Scout Rogue	2022-2024	FA209/2	FA209/2V	FA209/2HH			MD534	2
Scout	2015-2016	FA672	FA672V	FA672HH			MD534	3
Scout	2017-2024	FA209/2	FA209/2V	FA209/2HH			MD534	4
Scout Bobber	2019-2024	FA209/2	FA209/2V	FA209/2HH				5
Scout Bobber Twenty	2019-2024	FA209/2	FA209/2V	FA209/2HH				6
FTR 1200 ALL Models	2021-2025	FA630	FA630V*	FA630HH*	EPFA630HH*		MD803*	7
101 Scout	2025	FA630	FA630V*	FA630HH*				8
Scout Bobber	2025	FA209/2	FA209/2V	FA209/2HH				9
Scout Classic	2025	FA209/2	FA209/2V	FA209/2HH				10
Sport Scout	2025	FA209/2	FA209/2V	FA209/2HH				11
Super Scout	2025	FA209/2	FA209/2V	FA209/2HH				12
Scout All models	2002-2008	FA216/3	FA216/3V	FA216/3HH				13
Spirit All models	2002-2008	FA216/3	FA216/3V	FA216/3HH				14
Chief All models	2002-2008	FA216/3	FA216/3V	FA216/3HH				15
Bomber	2010-2011	FA95*	FA95V*	FA95HH*			MD535*	16
Chief Blackhawk	2011	FA95*	FA95V*	FA95HH*			MD535*	17
Chief Blackhawk Dark	2011	FA95*	FA95V*	FA95HH*			MD535*	18
Chief Classic	2011-2013	FA95*	FA95V*	FA95HH*			MD535*	19
Chief Deluxe	2009	FA95*	FA95V*	FA95HH*			MD535*	20
Chief Roadmaster	2009-2011	FA95*	FA95V*	FA95HH*			MD535*	21
Chief Standard	2009-2011	FA95*	FA95V*	FA95HH*			MD535*	22
Chief Vintage	2009-2013	FA95*	FA95V*	FA95HH*			MD535*	23
Chief Vintage	2014-2017			FA347HH*			MD890BLK*	24
Dark Horse	2010-2013	FA95*	FA95V*	FA95HH*			MD535*	25
Pursuit Dark Horse	2023-2024	FA630	FA630V	FA630HH*			MD803*	26
Pursuit Elite	2023	FA630	FA630V	FA630HH*			MD803*	27
Pursuit Limited	2022-2024	FA630	FA630V	FA630HH*			MD803*	28
Challenger 1800 All Models	2020-2025	FA630	FA630V	FA630HH*				29
Chief Classic	2014-2017			FA347HH*				30
Chief Dark Horse	2016-2020			FA347HH			MD890BLK	31
Chief Vintage	2018-2021			FA347HH*			MD890BLK*	32
Chieftain Dark Horse	2014-2015			FA347HH*			MD890BLK*	33
Chieftain Elite	2014-2019			FA347HH*			MD890BLK*	34
Chieftain Limited	2014-2019			FA347HH*			MD890BLK*	35
Chieftain	2014-2021			FA347HH*			MD890BLK*	36
Roadmaster Dark Horse	2015-2019			FA347HH*			MD890BLK*	37
Roadmaster Elite	2015-2019			FA347HH*			MD890BLK*	38
Roadmaster Limited	2015-2019			FA347HH*			MD890BLK*	39
Roadmaster	2015-2018			FA347HH*			MD890BLK*	40
Springfield	2016-2019			FA347HH*			MD890BLK*	41
Chieftain Dark Horse	2016-2024			FA347HH*			MD890BLK*	42
Chief 111/116 models	2022-2024			FA347HH			MD890BLK	43
Chief Bobber	2022-2024			FA347HH			MD890BLK	44
Chief Bobber Dark Horse	2022-2024			FA347HH			MD890BLK	45
Chief Dark Horse	2021-2024			FA347HH			MD890BLK	46
Chief Super Chief	2022-2024			FA347HH				47
Chief Super Chief Limited	2022-2024			FA347HH				48
Chieftain Limited	2023-2024			FA347HH*			MD890BLK*	49
Chieftain	2022-2024			FA347HH*			MD890BLK*	50
Roadmaster Dark Horse	2020-2024			FA347HH*			MD890BLK*	51
Roadmaster Dark Horse Jack Daniel's Edition	2021			FA347HH*			MD890BLK*	52
Roadmaster Elite	2020-2023			FA347HH*			MD890BLK*	53
Roadmaster Limited	2020-2024			FA347HH*			MD890BLK*	54
Roadmaster	2019-2024			FA347HH*			MD890BLK*	55

* symbol after part# = 2 pieces required i.e. 2 pad sets or 2 rotors (twin rotor models)

REAR: AMERICAN PRODUCED MOTORCYCLES



Line #

INDIAN

SUFFIX OR PREFIX
PAD MATERIALS AND DESCRIPTION

YEAR

REAR					REAR ROTOR OPTIONS	
PADS	PADS	PADS	PADS		DESIGN NO.	
FA	V	HH	EPFA			
Organic Pads	Semi-Sintered V-Pads™	Double-H™ USA-Made Sintered Pads	Premium Low Noise Street Sintered Pads		See Buyers Guide for rotor style & finish options. Part nos for ordering & sizing.	
1	Scout Bobber Sixty	2021-2024	FA213		FA213HH	
2	Scout Rogue	2022-2024	FA213		FA213HH	MD534
3	Scout	2015-2016	FA377X	FA377V		MD534
4	Scout	2017-2024	FA213		FA213HH	MD534
5	Scout Bobber	2019-2024	FA213		FA213HH	MD534
6	Scout Bobber Twenty	2019-2024	FA213		FA213HH	
7	FTR 1200 ALL Models	2021-2025	FA266		FA266HH	EPFA266HH MD8007
8	101 Scout	2025	FA213	FA213V	FA213HH	MD534
9	Scout Bobber	2025	FA213		FA213HH	MD534
10	Scout Classic	2025	FA213	FA213V	FA213HH	MD534
11	Sport Scout	2025	FA213	FA213V	FA213HH	MD534
12	Super Scout	2025	FA213	FA213V	FA213HH	MD534
13	Scout All models	2002-2008	FA216/3	FA216/3V	FA216/3HH	
14	Spirit All models	2002-2008	FA216/3	FA216/3V	FA216/3HH	
15	Chief All models	2002-2008	FA216/3	FA216/3V	FA216/3HH	
16	Bomber	2010-2011			FA696HH	MD535
17	Chief Blackhawk	2011			FA696HH	MD535
18	Chief Blackhawk Dark	2011			FA696HH	MD535
19	Chief Classic	2011-2013			FA696HH	MD535
20	Chief Deluxe	2009			FA696HH	MD535
21	Chief Roadmaster	2009-2011			FA696HH	MD535
22	Chief Standard	2009-2011			FA696HH	MD535
23	Chief Vintage	2009-2013			FA696HH	MD535
24	Chief Vintage	2014-2017	FA196	FA196V	FA196HH	MD887BLK
25	Dark Horse	2010-2013			FA696HH	MD535
26	Pursuit Dark Horse	2023-2024	FA196	FA196V	FA196HH	MD887BLK
27	Pursuit Elite	2023	FA196	FA196V	FA196HH	MD887BLK
28	Pursuit Limited	2022-2024	FA196	FA196V	FA196HH	MD887BLK
29	Challenger 1800 All Models	2020-2025	FA196	FA196V	FA196HH	
30	Chief Classic	2014-2017	FA196	FA196V	FA196HH	
31	Chief Dark Horse	2016-2020	FA196	FA196V	FA196HH	MD887BLK
32	Chief Vintage	2018-2021	FA196	FA196V	FA196HH	MD887BLK
33	Chieftain Dark Horse	2014-2015	FA196	FA196V	FA196HH	MD887BLK
34	Chieftain Elite	2014-2019	FA196	FA196V	FA196HH	MD887BLK
35	Chieftain Limited	2014-2019	FA196	FA196V	FA196HH	MD887BLK
36	Chieftain	2014-2021	FA196	FA196V	FA196HH	MD887BLK
37	Roadmaster Dark Horse	2015-2019	FA196	FA196V	FA196HH	MD887BLK
38	Roadmaster Elite	2015-2019	FA196	FA196V	FA196HH	MD887BLK
39	Roadmaster Limited	2015-2019	FA196	FA196V	FA196HH	MD887BLK
40	Roadmaster	2015-2018	FA196	FA196V	FA196HH	MD887BLK
41	Springfield	2016-2019	FA196	FA196V	FA196HH	MD887BLK
42	Chieftain Dark Horse	2016-2024	FA196	FA196V	FA196HH	MD887BLK
43	Chief 111/116 models	2022-2024	FA196	FA196V	FA196HH	
44	Chief Bobber	2022-2024	FA196	FA196V	FA196HH	
45	Chief Bobber Dark Horse	2022-2024	FA196	FA196V	FA196HH	
46	Chief Dark Horse	2021-2024	FA196	FA196V	FA196HH	MD887BLK
47	Chief Super Chief	2022-2024	FA196	FA196V	FA196HH	
48	Chief Super Chief Limited	2022-2024	FA196	FA196V	FA196HH	
49	Chieftain Limited	2023-2024	FA196	FA196V	FA196HH	MD887BLK
50	Chieftain	2022-2024	FA196	FA196V	FA196HH	MD887BLK
51	Roadmaster Dark Horse	2020-2024	FA196	FA196V	FA196HH	MD887BLK
52	Roadmaster Dark Horse Jack Daniel's Edition	2021	FA196	FA196V	FA196HH	MD887BLK
53	Roadmaster Elite	2020-2023	FA196	FA196V	FA196HH	MD887BLK
54	Roadmaster Limited	2020-2024	FA196	FA196V	FA196HH	MD887BLK
55	Roadmaster	2019-2024	FA196	FA196V	FA196HH	MD887BLK

All names & numbers are for reference purposes only. © Registered trademarks of Harley—Davidson® Motor Corp or Buell.

NOTE: — Some models may have a second rotor fitted as an optional extra. Please double check with your customer exactly which side the front rotor is fitted and if twin rotor or single.

* symbol after part# = 2 pieces required i.e. 2 pad sets or 2 rotors (twin rotor models)

Part numbers, prefixes, suffixes, photos and illustrations shown in this catalog are trademarks and/or copyrights of EBC Brakes or the trademark owner A C Freeman Investments Ltd and use without express written permission of the owners is punishable by law.

FRONT: AMERICAN PRODUCED MOTORCYCLES



SUFFIX OR PREFIX
PAD MATERIALS AND DESCRIPTION

YEAR

FRONT					FRONT ROTOR OPTIONS
PADS	PADS	PADS	PADS	DESIGN NO.	
FA	V	HH	EPFA		
Organic Pads	Semi-Sintered V-Pads™	Double-H™ USA-Made Sintered Pads	Premium Low Noise Street Sintered Pads	See Buyers Guide for rotor style & finish options. Part nos for ordering & sizing.	
INDIAN					
Springfield Dark Horse				MD890BLK*	1
Springfield				MD890BLK*	2
MOTUS					
MST					3
MSTR					4
MST-01					5
MSTR-01					6
POLARIS SLINGSHOT					
Sport Pad and Sport Rotor Options shown on page 72					
All SL Models 2.0L					7
Base 2.0L				MD533*	8
S 2.0L				MD533*	9
SL 2.0L				MD533*	10
SL LE 2.0L				MD533*	11
SLR 2.0L					12
R 2.0L					13
Rouse Edition 2.0L					14
VICTORY					
Octane 1200				MD534	15
Deluxe Cruiser				MD727	16
King Pin Tour				MD678	17
King Pin Tour				MD890BLK	18
King Pin				MD678	19
Standard Cruiser				MD727	20
Touring Cruiser				MD727*	21
Vegas 8-Ball				MD678	22
Vegas				MD678	23
Hammer S				MD678*	24
Hammer S				MD890BLK*	25
Hammer				MD678*	26
Hammer				MD890BLK*	27
Jackpot Cory Ness				MD678	28
Jackpot				MD678	29
Jackpot				MD890BLK	30
King Pin 8-Ball				MD678	31
King Pin Low				MD890BLK	32
King Pin				MD890BLK	33
Vegas 8-Ball				MD678	34
Vegas Jackpot				MD678	35
Vegas Jackpot				MD678	36
Vegas Low				MD678	37
Vegas				MD678	38
Broadwalk				MD890BLK	39
Cross Country 8-Ball				MD890BLK*	40
Cross Country Cory Ness Victory				MD890BLK*	41
Cross Country Touring				MD890BLK*	42
Cross Country				MD890BLK*	43
Cross Roads 8-Ball				MD890BLK*	44
Cross Roads Classic				MD890BLK*	45
Cross Roads				MD890BLK*	46
Gunner				MD890BLK	47

* symbol after part# = 2 pieces required i.e. 2 pad sets or 2 rotors (twin rotor models)

FRONT: AMERICAN PRODUCED MOTORCYCLES



SUFFIX OR PREFIX
PAD MATERIALS AND DESCRIPTION

YEAR

FRONT					FRONT ROTOR OPTIONS	Line #	
PADS	PADS	PADS	PADS	DESIGN NO.			
FA	V	HH	EPFA	DESIGN NO.			
Organic Pads	Semi-Sintered V-Pads™	Double-H™ USA-Made Sintered Pads	Premium Low Noise Street Sintered Pads	See Buyers Guide for rotor style & finish options. Part nos for ordering & sizing.			
Hammer 8-Ball	2010-2015		FA347HH	EPFA347HH	MD678	1	
Hammer 8-Ball	2016		FA347HH*	EPFA347HH*	MD890BLK*	2	
Hard Ball	2012-2013		FA347HH*	EPFA347HH*	MD678*	3	
High Ball	2012-2017		FA347HH	EPFA347HH	MD890BLK	4	
Judge	2013-2017		FA347HH	EPFA347HH	MD890BLK	5	
Magnum X-1	2015-2017		FA347HH*	EPFA347HH*	MD890BLK	6	
Magnum	2015-2017		FA347HH*	EPFA347HH*	MD890BLK	7	
Ness Signature Series	2005-2007	FA244	FA244V	FA244HH	EPFA244HH	MD678	8
Special Edition	2000	FA244	FA244V	FA244HH	EPFA244HH	MD727	9
Sport Cruiser	2000-2001	FA244*	FA244V*	FA244HH*	EPFA244HH*	MD727*	10
Vegas 8-Ball/ Vegas Zach Ness/Vegas	2011-2017			FA347HH	EPFA347HH	MD678	11
Vision 8-Ball	2010-2011			FA261HH*	EPFA261HH*	MD678	12
Vision Arlen Ness Victory Vision	2010-2012			FA261HH*	EPFA261HH*	MD890BLK*	13
Vision Street	2008-2009			FA261HH*	EPFA261HH*	MD678	14
Vision Tour - All models	2008-2015			FA261HH*	EPFA261HH*	MD890BLK*	15
Empulse TT	2016	FA244*	FA244V*	FA244HH*	EPFA244HH*	MD890BLK*	16
ZERO ELECTRIC						17	
DS ZF13.0	2016-2019	FA209/2		FA209/2HH		18	
DS II ZF14.4	2019-2021	FA209/2		FA209/2HH		19	
DS II 14.4	2022-2024	FA244		FA244HH	MD8024X	20	
DS II ZF9.4/ZF12.5	2015	FA209/2		FA209/2HH		21	
DSR ZF13.0	2017-2019	FA209/2		FA209/2HH		22	
DSR ZF14.4.0	2019-2022	FA209/2		FA209/2HH		23	
DSR ZF7.2	2019-2022	FA209/2		FA209/2HH		24	
DSR ZF15.6	2023-2024	FA244		FA244HH	MD8024X	25	
DSR/X ZF75-10X 17.3.0 Adventure	2022-2025	FA244*		FA244HH*	MD8024X	26	
FX Black Forest Edition - ZF14.4.0	2019-2021	FA209/2		FA209/2HH		27	
FX ZF2.8/ZF5.7	2013-2014	FA185X		FA185R		28	
FX ZF2.8/ZF5.7	2015	FA181X		FA181R		29	
FX ZF3.3/ZF6.5	2016-2022	FA209/2		FA209/2HH		30	
FX ZF7.2	2023-2024	FA209/2		FA209/2HH		31	
FXE ZF7.2	2022-2024	FA209/2		FA209/2HH		32	
FXS ZF3.3/ZF6.5	2017-2022	FA209/2		FA209/2HH		33	
S ZF14.4	2019-2025	FA209/2		FA209/2HH	MD8024X	34	
S ZF7.2	2019-2022	FA209/2		FA209/2HH		35	
S ZF8.5/ZF11.4	2013	FA185X		FA185R		36	
S ZF8.5/ZF11.4	2014	FA185X		FA185R		37	
S ZF9.4/ZF12.5	2015	FA209/2		FA209/2HH		38	
S ZF9.8/ZF13.0	2016-2019	FA209/2		FA209/2HH		39	
SR ZF12.5	2015	FA209/2		FA209/2HH		40	
SR ZF13.0	2016-2022	FA209/2		FA209/2HH		41	
SR/F ZF - SR/S ZF 14.4 kWh	2019-2024	FA244*		FA244HH*	MD8024X	42	
						43	
						44	
						45	
						46	
						47	
						48	
						49	
						50	
						51	
						52	
						53	
						54	
						55	

* symbol after part# = 2 pieces required i.e. 2 pad sets or 2 rotors (twin rotor models)

REAR: AMERICAN PRODUCED MOTORCYCLES



Line #

VICTORY

SUFFIX OR PREFIX
PAD MATERIALS AND DESCRIPTION

YEAR

REAR					REAR ROTOR OPTIONS		
PADS	PADS	PADS	PADS		DESIGN NO.		
FA	V	HH	EPFA				
Organic Pads	Semi-Sintered V-Pads™	Double-H™ USA-Made Sintered Pads	Premium Low Noise Street Sintered Pads		See Buyers Guide for rotor style & finish options. Part nos for ordering & sizing.		
1	Hammer 8-Ball	2010-2015	FA196	FA196V	FA196HH	EPFA196HH	MD890BLK
2	Hammer 8-Ball	2016	FA196	FA196V	FA196HH	EPFA196HH	MD890BLK
3	Hard Ball	2012-2013	FA196	FA196V	FA196HH	EPFA196HH	MD887BLK
4	High Ball	2012-2017	FA196	FA196V	FA196HH	EPFA196HH	MD890BLK
5	Judge	2013-2017	FA196	FA196V	FA196HH	EPFA196HH	MD890BLK
6	Magnum X-1	2015-2017	FA196	FA196V	FA196HH	EPFA196HH	MD887BLK
7	Magnum	2015-2017	FA196	FA196V	FA196HH	EPFA196HH	MD887BLK
8	Ness Signature Series	2005-2007	FA209/2	FA209/2V	FA209/2HH	EPFA209/2HH	MD678
9	Special Edition	2000	FA209/2	FA209/2V	FA209/2HH	EPFA209/2HH	MD727
10	Sport Cruiser	2000-2001	FA209/2	FA209/2V	FA209/2HH	EPFA209/2HH	MD727
11	Vegas 8-Ball/ Vegas Zach Ness/Vegas	2011-2017	FA196	FA196V	FA196HH	EPFA196HH	MD678
12	Vision 8-Ball	2010-2011	FA196	FA196V	FA196HH	EPFA196HH	MD887BLK
13	Vision Arlen Ness Victory Vision	2010-2012	FA196	FA196V	FA196HH	EPFA196HH	MD887BLK
14	Vision Street	2008-2009	FA196	FA196V	FA196HH	EPFA196HH	MD887BLK
15	Vision Tour - All models	2008-2015	FA196	FA196V	FA196HH	EPFA196HH	MD887BLK
16	Empulse TT	2016	FA266	FA266V	FA266HH	EPFA266HH	MD887BLK
17	ZERO ELECTRIC						
18							
19	DS ZF13.0	2016-2019	FA213		FA213HH		
20	DS II ZF14.4	2019-2021	FA213		FA213HH		
21	DS II 14.4	2022-2024	FA209/2		FA209/2HH		
22	DS II ZF9.4/ZF12.5	2015	FA213		FA213HH		
23	DSR ZF13.0	2017-2019	FA213		FA213HH		
24	DSR ZF14.4.0	2019-2022	FA213		FA213HH		
25	DSR ZF7.2	2019-2022	FA213		FA213HH		
26	DSR ZF15.6	2023-2024	FA209/2		FA209/2HH		
27	DSR/X ZF75-10X 17.3.0 Adventure	2022-2023	FA209/2		FA209/2HH		
28	FX Black Forest Edition - ZF14.4.0	2019-2021	FA213		FA213HH		
29	FX ZF2.8/ZF5.7	2013-2014	FA367X		FA367R		
30	FX ZF2.8/ZF5.7	2015	FA208X		FA208R		
31	FX ZF3.3/ZF6.5	2016-2022	FA213		FA213HH		
32	FX ZF7.2	2023-2024	FA213		FA213HH		
33	FXE ZF7.2	2022-2024	FA213		FA213HH		
34	FXS ZF3.3/ZF6.5	2017-2022	FA213		FA213HH		
35	S ZF14.4	2019-2025	FA213		FA213HH		
36	S ZF7.2	2019-2022	FA213		FA213HH		
37	S ZF8.5/ZF11.4	2013	FA367X		FA367R		
38	S ZF8.5/ZF11.4	2014	FA208X		FA208R		
39	S ZF9.4/ZF12.5	2015	FA213		FA213HH		
40	S ZF9.8/ZF13.0	2016-2019	FA213		FA213HH		
41	SR ZF12.5	2015	FA213		FA213HH		
42	SR ZF13.0	2016-2022	FA213		FA213HH		
43	SR/F ZF - SR/S ZF 14.4 kWh	2019-2024	FA213		FA213HH		
44							
45							
46							
47							
48							
49							
50							
51							
52							
53							
54							
55							

All names & numbers are for reference purposes only. © Registered trademarks of Harley—Davidson® Motor Corp or Buell.

NOTE: — Some models may have a second rotor fitted as an optional extra. Please double check with your customer exactly which side the front rotor is fitted and if twin rotor or single.

* symbol after part# = 2 pieces required i.e. 2 pad sets or 2 rotors (twin rotor models)

Part numbers, prefixes, suffixes, photos and illustrations shown in this catalog are trademarks and/or copyrights of EBC Brakes or the trademark owner A C Freeman Investments Ltd and use without express written permission of the owners is punishable by law.

PADS FOR AFTERMARKET CALIPERS



BERINGER

SUFFIX OR PREFIX PAD MATERIALS AND DESCRIPTION	FA	V	HH	EPFA
	Organic Pads	Semi-Sintered V-Pads™	Double-H™/MXS USA-Made Sintered Pads	Premium Low Noise Street Sintered Pads
4 Piston Old Design	FA158		FA158HH	EPFA158HH
4 Piston Radial			MXS405	EPFA405HH
6 Piston Old Design	FA249		FA249HH	EPFA249HH
6 Piston Old design/2 piston	FA47		FA47HH	
6 Piston Old Design Endurance	FA249/2			
6 Piston New Design			MXS406	

GMA

2 Piston rear large caliper model A CCI #09997	FA36	FA36V		
2 Piston small caliper model B CCI # 09996	FA76	FA76V	FA76HH	
4 Piston model F	FA115	FA115V	FA115HH	

IRON PEGASUS

Small caliper Single Pin Fixing	FA47		FA47HH	
Small caliper 2 Pin Fixing JayBrake Calipers	FA115	FA115V	FA115HH	

JAYBRAKE

Dual Quad 30004 2 & 4 Piston	FA115	FA115V	FA115HH	
JFour 30044 4 Piston	FA188		FA188HH	EPFA188HH
JSix 30064 6 Piston	FA243		FA243HH	
6 PFL 6 Piston for 13" Rotor Full Height Friction			FA455HH	
6 PFL 6 Piston for 11.5" Rotor Lower Height Friction			FA649HH	
Early Design 2 Piston	FA76	FA76V	FA76HH	

PERFORMANCE MACHINE

112 X 6B	FA249		FA249HH	EPFA249HH
112 X 6QC	FA249		FA249HH	EPFA249HH
112 X 6RSB	FA190	FA190V	FA190HH	EPFA190HH
112 X 6SSB	FA190	FA190V	FA190HH	EPFA190HH
124 X 4HR	FA216/2		FA216/2HH	
125 X 2	FA115	FA115V	FA115HH	
125 X 4R	FA216/3	FA216/3V	FA216/3HH	
125 X 4RSPH	FA216/3	FA216/3V	FA216/3HH	
125 X 4S	FA115	FA115V	FA115HH	
125 X 4SL	FA115	FA115V	FA115HH	
125 X 6	FA210	FA210V		
125 X 6QC	FA190	FA190V	FA190HH	
137 X 4	FA216/2		FA216/2HH	
137 X 4 2006			FA420HH	
137 X 4B	FA216/3	FA216/3V	FA216/3HH	
137 X 6	FA210	FA210V		
162 X 2	FA32	FA32V		

REVTECH

CCI Polished Caliper FrontRear	FA95	FA95V	FA95HH	EPFA95HH
New Black 4 Piston Caliper	FA216/3	FA216/3V	FA216/3HH	

WILWOOD

PS1 Caliper Part # 1504091K	FA271X		FA271R	
GP300310 Part # 15087332	FA95	FA95V	FA95HH	EPFA95HH
GP320 Part # 1548596K	FA95			

* symbol after part# = 2 pieces required i.e. 2 pad sets or 2 rotors (twin rotor models)

EBC BRAKE PAD BUYERS GUIDE

FA24/2 113.5 x 64.5 x 7mm



BANANA CALIPER

MATERIAL AVAILABILITY					
FA	X	V	R	HH	EPFA
●		●			

FA26 75.5 x 50 x 7mm



Complete with four rivets

MATERIAL AVAILABILITY					
FA	X	V	R	HH	EPFA
●					

FA36 58 x 54 x 9mm



MATERIAL AVAILABILITY					
FA	X	V	R	HH	EPFA
●		●			

FA47 40 x 50.5 x 7mm



MATERIAL AVAILABILITY					
FA	X	V	R	HH	EPFA
●	●	●		●	

FA71 53.5 x 68.5 x 6.5mm



MATERIAL AVAILABILITY					
FA	X	V	R	HH	EPFA
●		●			

FA72 71 x 89 x 6.5mm



MATERIAL AVAILABILITY					
FA	X	V	R	HH	EPFA
●		●			

FA76 48.5 x 58 x 7mm



MATERIAL AVAILABILITY					
FA	X	V	R	HH	EPFA
●		●		●	

FA78 74.5 x 49 x 12mm



GIRLING CALIPER

MATERIAL AVAILABILITY					
FA	X	V	R	HH	EPFA
●		●		●	

FA79 174.5 x 72.5 x 10mm



MATERIAL AVAILABILITY					
FA	X	V	R	HH	EPFA
●		●			

FA83 A. 47.5 x 37 x 9mm

B. 85.5 x 42.5 x 7mm



MATERIAL AVAILABILITY					
FA	X	V	R	HH	EPFA
	●			●	●

FA86 77 x 42 x 7.5mm



MATERIAL AVAILABILITY					
FA	X	V	R	HH	EPFA
●				●	

FA94 56 x 60 x 13mm



HAYES CALIPER

MATERIAL AVAILABILITY					
FA	X	V	R	HH	EPFA
●		●		●	●

FA95 69.5 x 51 x 8mm



MATERIAL AVAILABILITY					
FA	X	V	R	HH	EPFA
●		●		●	●

FA115 36 x 45 x 6mm



MATERIAL AVAILABILITY					
FA	X	V	R	HH	EPFA
●		●		●	

EBC BRAKE PAD BUYERS GUIDE

FA135 A 97 x 42 x 7.5mm
B 77 x 42 x 7.5mm



MATERIAL AVAILABILITY					
FA	X	V	R	HH	EPFA
	●		●		

FA140 86.5 x 39.5 x 10mm



MATERIAL AVAILABILITY					
FA	X	V	R	HH	EPFA
●		●		●	

FA158 70 x 46.5 x 8mm



MATERIAL AVAILABILITY					
FA	X	V	R	HH	EPFA
●				●	●

FA165 A 97 x 42 x 7.5mm
B 77 x 42 x 7.5mm



MATERIAL AVAILABILITY					
FA	X	V	R	HH	EPFA
	●		●		

FA175 33.5 x 51 x 7mm



MATERIAL AVAILABILITY					
FA	X	V	R	HH	EPFA
●				●	

FA181 94 x 36.5 x 7.5mm



MATERIAL AVAILABILITY					
FA	X	V	R	HH	EPFA
	●	●	●	●	●

FA185 94 x 33.5 x 7mm



MATERIAL AVAILABILITY					
FA	X	V	R	HH	EPFA
	●		●		●

FA188 89.5 x 53 x 9mm (inc fitted shim)



MATERIAL AVAILABILITY					
FA	X	V	R	HH	EPFA
●				●	●

FA190 99 x 49.5 x 10mm



MATERIAL AVAILABILITY					
FA	X	V	R	HH	EPFA
●		●		●	●

FA196 102 x 39 x 10mm



MATERIAL AVAILABILITY					
FA	X	V	R	HH	EPFA
●		●		●	●

FA200 103 x 62 x 11.5mm



INCLUDES STEEL SLIDER SHIMS.
PLEASE REFER TO TECH PAGES
AT THE FRONT OF HANDBOOK

MATERIAL AVAILABILITY					
FA	X	V	R	HH	EPFA
●		●		●	●

FA201 103 x 62 x 11.5mm



INCLUDES STEEL SLIDER SHIMS.
PLEASE REFER TO TECH PAGES
AT THE FRONT OF HANDBOOK

MATERIAL AVAILABILITY					
FA	X	V	R	HH	EPFA
●		●		●	●

FA208 78 x 41 x 9mm



MATERIAL AVAILABILITY					
FA	X	V	R	HH	EPFA
	●		●		

FA209/2 108.5 x 40.5 x 7.5mm



MATERIAL AVAILABILITY					
FA	X	V	R	HH	EPFA
●		●		●	●

EBC BRAKE PAD BUYERS GUIDE

FA210 112 x 56.5 x 10mm



MATERIAL AVAILABILITY					
FA	X	V	R	HH	EPFA
●		●			

FA213 78 x 41.5 x 9mm



MATERIAL AVAILABILITY					
FA	X	V	R	HH	EPFA
●		●		●	●

FA216/2 69 x 50.5 x 10.5mm



MATERIAL AVAILABILITY					
FA	X	V	R	HH	EPFA
●				●	

FA216/3 69 x 50.5 x 8mm



MATERIAL AVAILABILITY					
FA	X	V	R	HH	EPFA
●		●		●	

FA243 98.5 x 49.5 x 8.5mm



MATERIAL AVAILABILITY					
FA	X	V	R	HH	EPFA
●				●	

FA244 75 x 55 x 8.5mm



MATERIAL AVAILABILITY					
FA	X	V	R	HH	EPFA
●		●		●	●

FA249 91.5 x 51.5 x 10mm



MATERIAL AVAILABILITY					
FA	X	V	R	HH	EPFA
●				●	●

FA251 A. 85 x 42.5 x 8mm
B. 55.5 x 37 x 10mm



MATERIAL AVAILABILITY					
FA	X	V	R	HH	EPFA
●					

FA254 60 x 57 x 8mm



MATERIAL AVAILABILITY					
FA	X	V	R	HH	EPFA
●		●		●	●

FA261 116 x 40.5 x 8.5mm



MATERIAL AVAILABILITY					
FA	X	V	R	HH	EPFA
		●		●	●

FA264 A. 84.5 x 43.5 x 8mm
B. 70 x 41 x 8mm



MATERIAL AVAILABILITY					
FA	X	V	R	HH	EPFA
●				●	

FA266 51.5 x 54.5 x 7.5mm



MATERIAL AVAILABILITY					
FA	X	V	R	HH	EPFA
●		●		●	●

FA296 75 x 55 x 7.5mm



MATERIAL AVAILABILITY					
FA	X	V	R	HH	EPFA
				●	●

FA317 A. 82 x 41 x 9.5mm
B. 62 x 41 x 9.5mm



MATERIAL AVAILABILITY					
FA	X	V	R	HH	EPFA
	●			●	

EBC BRAKE PAD BUYERS GUIDE

FA345 91.5 x 49.5 x 8mm



6 piston caliper can refit original backing shim if desired

MATERIAL AVAILABILITY					
FA	X	V	R	HH	EPFA
				●	●

FA347 69.5 x 49.5 x 7mm



MATERIAL AVAILABILITY					
FA	X	V	R	HH	EPFA
				●	●

FA367 67 x 36 x 11mm



MATERIAL AVAILABILITY					
FA	X	V	R	HH	EPFA
	●		●		●

FA377 A 94 x 47 x 8.5mm
B 73 x 47 x 11mm

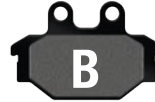

MATERIAL AVAILABILITY					
FA	X	V	R	HH	EPFA
●		●		●	

FA381 102 x 45.5 x 11mm



MATERIAL AVAILABILITY					
FA	X	V	R	HH	EPFA
●		●		●	●

FA387 86.5 x 44.5 x 10.5mm



MATERIAL AVAILABILITY					
FA	X	V	R	HH	EPFA
●		●		●	●

FA400 98 x 64 x 8mm
HH = 7.5mm thickness



MATERIAL AVAILABILITY					
FA	X	V	R	HH	EPFA
●		●		●	●

FA409 92 x 58.5 x HH/EPFA = 7mm
92 x 58.5 x FA/FA-V = 8mm



MATERIAL AVAILABILITY					
FA	X	V	R	HH	EPFA
●		●		●	●

FA420 69.5 x 54.5 x 8mm



MATERIAL AVAILABILITY					
FA	X	V	R	HH	EPFA
				●	

FA424 91.5 x 51.5 x 8mm



MATERIAL AVAILABILITY					
FA	X	V	R	HH	EPFA
●				●	●

FA434 A/B 98 x 64 x 8mm



NOTE: Will not interchange with FA299 or FA400.
Check old pad shape against drawing to ensure correct pad selected.

MATERIAL AVAILABILITY					
FA	X	V	R	HH	EPFA
●		●		●	

FA435/4 43.5 x 49 x 9.5mm



MATERIAL AVAILABILITY					
FA	X	V	R	HH	EPFA
				●	●

FA447 102 x 42 x 7.5mm



MATERIAL AVAILABILITY					
FA	X	V	R	HH	EPFA
				●	●

FA454/4 61.5 x 46.5 x 7.5mm (inc shims)



MATERIAL AVAILABILITY					
FA	X	V	R	HH	EPFA
				●	●

EBC BRAKE PAD BUYERS GUIDE

FA455 99 x 54.5 x 9mm



MATERIAL AVAILABILITY					
FA	X	V	R	HH	EPFA
				●	

FA457 90.5 x 62 x 8mm



MATERIAL AVAILABILITY					
FA	X	V	R	HH	EPFA
●		●		●	●

FA458 127.5 x 52.5 x HH/EPFA = 7.5mm
127.5 x 52.5 x FA-V = 8mm



MATERIAL AVAILABILITY					
FA	X	V	R	HH	EPFA
●		●		●	●

FA460 46.5 x 49.5 x 7mm



MATERIAL AVAILABILITY					
FA	X	V	R	HH	EPFA
				●	

FA473 110.5 x 53.5 x 8mm



MATERIAL AVAILABILITY					
FA	X	V	R	HH	EPFA
●		●			

FA474 75.5 x 33 x 8mm



MATERIAL AVAILABILITY					
FA	X	V	R	HH	EPFA
●		●			

FA605/4 97.5 x 46.5 x 7mm Hardware included



MATERIAL AVAILABILITY					
FA	X	V	R	HH	EPFA
		●		●	

FA630 85 x 50.5 x 8mm



MATERIAL AVAILABILITY					
FA	X	V	R	HH	EPFA
●		●		●	●

FA631 96.5 x 43.5 x 8mm



MATERIAL AVAILABILITY					
FA	X	V	R	HH	EPFA
●		●		●	

FA638 173.5 x 48.5 x HH/EPFA = 7mm
FA/FA-V = 8mm



MATERIAL AVAILABILITY					
FA	X	V	R	HH	EPFA
●		●		●	●

FA640 118 x 48.5 x 9.5mm



MATERIAL AVAILABILITY					
FA	X	V	R	HH	EPFA
●		●		●	●

FA641/4 88 x 43 x 8mm



MATERIAL AVAILABILITY					
FA	X	V	R	HH	EPFA
●		●		●	

FA643 94 x 36.5 x 9mm









MATERIAL AVAILABILITY					
FA	X	V	R	HH	EPFA
		●		●	

FA649 99 x 55 x 8.5mm









MATERIAL AVAILABILITY					
FA	X	V	R	HH	EPFA
				●	

EBC BRAKE PAD BUYERS GUIDE

<p>FA669/4 137.5 x 49.5 x 15mm (4 pad set)</p>  <table border="1" data-bbox="430 304 792 399"> <thead> <tr> <th colspan="6">MATERIAL AVAILABILITY</th> </tr> <tr> <th>FA</th> <th>X</th> <th>V</th> <th>R</th> <th>HH</th> <th>EPFA</th> </tr> </thead> <tbody> <tr> <td>●</td> <td></td> <td></td> <td></td> <td></td> <td></td> </tr> </tbody> </table>	MATERIAL AVAILABILITY						FA	X	V	R	HH	EPFA	●						<p>FA670 137.5 x 49.5 x 6mm (2 pad set)</p>  <table border="1" data-bbox="1128 304 1490 399"> <thead> <tr> <th colspan="6">MATERIAL AVAILABILITY</th> </tr> <tr> <th>FA</th> <th>X</th> <th>V</th> <th>R</th> <th>HH</th> <th>EPFA</th> </tr> </thead> <tbody> <tr> <td>●</td> <td></td> <td></td> <td></td> <td></td> <td></td> </tr> </tbody> </table>	MATERIAL AVAILABILITY						FA	X	V	R	HH	EPFA	●					
MATERIAL AVAILABILITY																																					
FA	X	V	R	HH	EPFA																																
●																																					
MATERIAL AVAILABILITY																																					
FA	X	V	R	HH	EPFA																																
●																																					
<p>FA672 114.5 x 38.5 x 9.5mm</p>  <table border="1" data-bbox="430 571 792 665"> <thead> <tr> <th colspan="6">MATERIAL AVAILABILITY</th> </tr> <tr> <th>FA</th> <th>X</th> <th>V</th> <th>R</th> <th>HH</th> <th>EPFA</th> </tr> </thead> <tbody> <tr> <td>●</td> <td></td> <td>●</td> <td></td> <td>●</td> <td>●</td> </tr> </tbody> </table>	MATERIAL AVAILABILITY						FA	X	V	R	HH	EPFA	●		●		●	●	<p>FA696 55 x 53.5 x 9mm</p>  <table border="1" data-bbox="1128 571 1490 665"> <thead> <tr> <th colspan="6">MATERIAL AVAILABILITY</th> </tr> <tr> <th>FA</th> <th>X</th> <th>V</th> <th>R</th> <th>HH</th> <th>EPFA</th> </tr> </thead> <tbody> <tr> <td>●</td> <td></td> <td>●</td> <td></td> <td>●</td> <td>●</td> </tr> </tbody> </table>	MATERIAL AVAILABILITY						FA	X	V	R	HH	EPFA	●		●		●	●
MATERIAL AVAILABILITY																																					
FA	X	V	R	HH	EPFA																																
●		●		●	●																																
MATERIAL AVAILABILITY																																					
FA	X	V	R	HH	EPFA																																
●		●		●	●																																
<p>FA710 82 x 42 x 10mm</p>  <table border="1" data-bbox="430 835 792 930"> <thead> <tr> <th colspan="6">MATERIAL AVAILABILITY</th> </tr> <tr> <th>FA</th> <th>X</th> <th>V</th> <th>R</th> <th>HH</th> <th>EPFA</th> </tr> </thead> <tbody> <tr> <td>●</td> <td></td> <td>●</td> <td></td> <td>●</td> <td>●</td> </tr> </tbody> </table>	MATERIAL AVAILABILITY						FA	X	V	R	HH	EPFA	●		●		●	●	<p>FA760 83 x 49 x 8mm</p>  <table border="1" data-bbox="1128 835 1490 930"> <thead> <tr> <th colspan="6">MATERIAL AVAILABILITY</th> </tr> <tr> <th>FA</th> <th>X</th> <th>V</th> <th>R</th> <th>HH</th> <th>EPFA</th> </tr> </thead> <tbody> <tr> <td>●</td> <td></td> <td>●</td> <td></td> <td>●</td> <td>●</td> </tr> </tbody> </table>	MATERIAL AVAILABILITY						FA	X	V	R	HH	EPFA	●		●		●	●
MATERIAL AVAILABILITY																																					
FA	X	V	R	HH	EPFA																																
●		●		●	●																																
MATERIAL AVAILABILITY																																					
FA	X	V	R	HH	EPFA																																
●		●		●	●																																

KEY GUIDE

Please see guide below for actual friction material and plate colour.

<p>Sport. Organic (FA) ●</p> 	<p>Moto-x-sport (X) ●</p> 	<p>Touring. Semi-Sintered (V) ●</p> 
<p>ATV & Moto-X. Sintered (R) ●</p> 	<p>Streetbikes. Sintered (HH) ●</p> 	<p>Premium ultra silent sintered grade (EPFA) ●</p> 

ROTOR GROUP NO. 001 - FRONT. CHOOSE YOUR PREFERRED STYLE:

Type	Solid	OD	11.5" / 290mm
Color /Finish	Natural	Thickness	0.196" / 5mm
Bobbins	None	Bore	2.22" / 56.4mm
F/R	Front	Bolt Holes	Counterbored



FSD008
Fits EBC Pads: 94, 381, 400, 457

Type	Floating	OD	11.5" / 290mm
Color /Finish	Polished	Thickness	0.196" / 5mm
Bobbins	5	Bore	2.22" / 56.4mm
F/R	Front	Bolt Holes	Counterbored

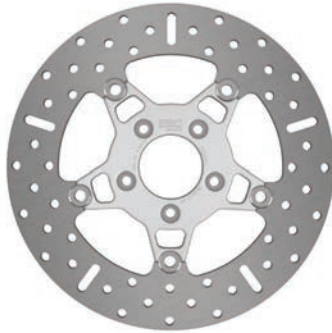

FSD010
Fits EBC Pads: 94, 381, 400, 457

Type	Floating	OD	11.5" / 290mm
Color /Finish	Black	Thickness	0.196" / 5mm
Bobbins	5	Bore	2.22" / 56.4mm
F/R	Front	Bolt Holes	Counterbored



FSD010BLK
Fits EBC Pads: 94, 381, 400, 457

Type	Floating	OD	11.5" / 290mm
Color /Finish	Polished	Thickness	0.196" / 5mm
Bobbins	5	Bore	2.22" / 56.4mm
F/R	Front	Bolt Holes	Counterbored

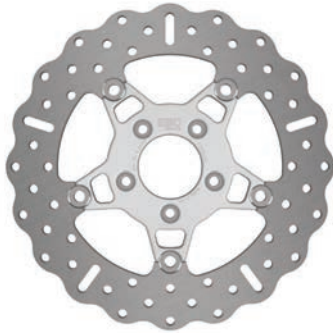

FSD012C
Fits EBC Pads: 94, 381, 400, 457

Type	Floating	OD	11.5" / 290mm
Color /Finish	Black	Thickness	0.196" / 5mm
Bobbins	5	Bore	2.22" / 56.4mm
F/R	Front	Bolt Holes	Counterbored



FSD012CBLK
Fits EBC Pads: 94, 381, 400, 457

Type	Floating	OD	11.5" / 290mm
Color /Finish	Black	Thickness	0.196" / 5mm
Bobbins	5	Bore	2.22" / 56.4mm
F/R	Front	Bolt Holes	Counterbored



VR010BLK
Fits EBC Pads: 94, 381, 400, 457

Type	Floating	OD	11.5" / 290mm
Color /Finish	Black	Thickness	0.196" / 5mm
Bobbins	10	Bore	2.22" / 56.4mm
F/R	Front	Bolt Holes	Counterbored



FSD023BLK
Fits EBC Pads: 94, 381, 400, 457

Type	Floating	OD	11.5" / 290mm
Color /Finish	Polished	Thickness	0.196" / 5mm
Bobbins	10	Bore	2.22" / 56.4mm
F/R	Front	Bolt Holes	Counterbored

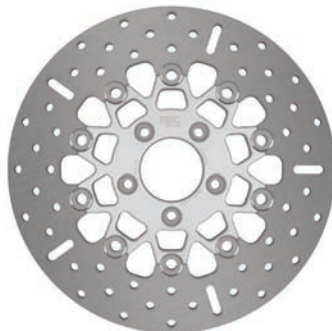

FSD023
Fits EBC Pads: 94, 381, 400, 457

Type	Floating	OD	11.5" / 290mm
Color /Finish	Black	Thickness	0.196" / 5mm
Bobbins	10	Bore	2.22" / 56.4mm
F/R	Front	Bolt Holes	Counterbored



FSD027CBLK
Fits EBC Pads: 94, 381, 400, 457

Type	Floating	OD	11.5" / 290mm
Color /Finish	Polished	Thickness	0.196" / 5mm
Bobbins	10	Bore	2.22" / 56.4mm
F/R	Front	Bolt Holes	Counterbored

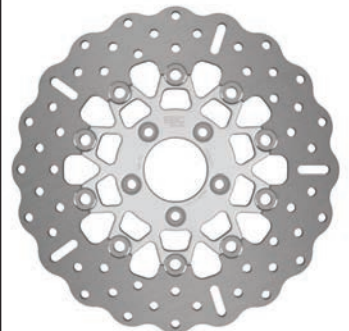

FSD027C
Fits EBC Pads: 94, 381, 400, 457

ROTOR GROUP NO. 002 - FRONT. CHOOSE YOUR PREFERRED STYLE:

Type	Solid	OD	11.5" / 290mm
Color /Finish	Natural	Thickness	0.196" / 5mm
Bobbins	None	Bore	1.99" / 50.6mm
F/R	Front	Bolt Holes	Counterbored



FSD007
Fits EBC Pads: 94, 216/3

Type	Floating	OD	11.5" / 290mm
Color /Finish	Polished	Thickness	0.196" / 5mm
Bobbins	5	Bore	1.99" / 50.6mm
F/R	Front	Bolt Holes	Counterbored

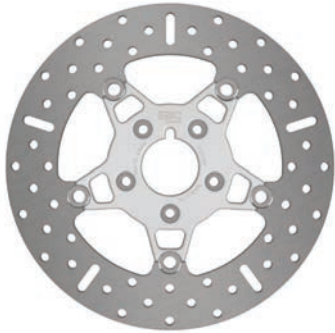

FSD009
Fits EBC Pads: 94, 216/3

Type	Floating	OD	11.5" / 290mm
Color /Finish	Black	Thickness	0.196" / 5mm
Bobbins	5	Bore	1.99" / 50.6mm
F/R	Front	Bolt Holes	Counterbored



FSD009BLK
Fits EBC Pads: 94, 216/3

Type	Floating	OD	11.5" / 290mm
Color /Finish	Polished	Thickness	0.196" / 5mm
Bobbins	5	Bore	1.99" / 50.6mm
F/R	Front	Bolt Holes	Counterbored

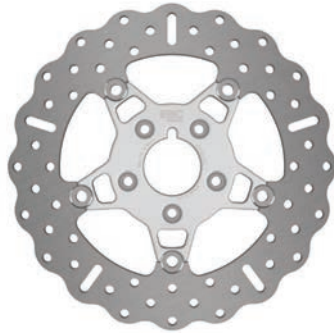

FSD011C
Fits EBC Pads: 94, 216/3

Type	Floating	OD	11.5" / 290mm
Color /Finish	Black	Thickness	0.196" / 5mm
Bobbins	5	Bore	1.99" / 50.6mm
F/R	Front	Bolt Holes	Counterbored



FSD011CBLK
Fits EBC Pads: 94, 216/3

Type	Floating	OD	11.5" / 290mm
Color /Finish	Polished	Thickness	0.196" / 5mm
Bobbins	10	Bore	1.99" / 50.6mm
F/R	Front	Bolt Holes	Counterbored

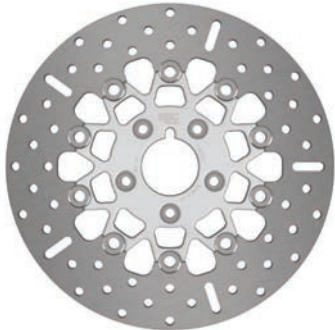

FSD022
Fits EBC Pads: 94, 216/3

Type	Floating	OD	11.5" / 290mm
Color /Finish	Black	Thickness	0.196" / 5mm
Bobbins	10	Bore	1.99" / 50.6mm
F/R	Front	Bolt Holes	Counterbored

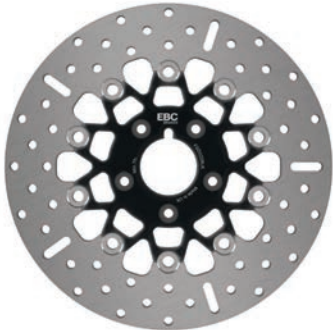

FSD022BLK
Fits EBC Pads: 94, 216/3

Type	Floating	OD	11.5" / 290mm
Color /Finish	Polished	Thickness	0.196" / 5mm
Bobbins	10	Bore	1.99" / 50.6mm
F/R	Front	Bolt Holes	Counterbored

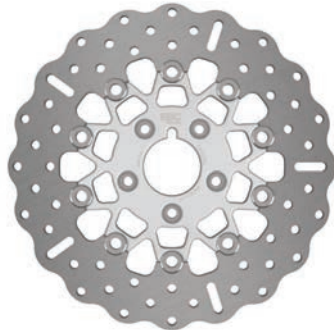

FSD026C
Fits EBC Pads: 94, 216/3

Type	Floating	OD	11.5" / 290mm
Color /Finish	Black	Thickness	0.196" / 5mm
Bobbins	10	Bore	1.99" / 50.6mm
F/R	Front	Bolt Holes	Counterbored



FSD026CBLK
Fits EBC Pads: 94, 216/3

Type	Floating	OD	11.5" / 290mm
Color /Finish	Black	Thickness	0.196" / 5mm
Bobbins	5	Bore	1.99" / 50.6mm
F/R	Front	Bolt Holes	Counterbored



VR011BLK
Fits EBC Pads: 94, 216/3

5 button or 10 button Floating Rotors

Light duty 5 button rotors are designed for bikes with a TWIN front rotor set up.

Heavy duty 10 button rotors are designed for bikes with a SINGLE front rotor set up.

ROTOR GROUP NO. 003 - REAR. CHOOSE YOUR PREFERRED STYLE:

Type	Floating	OD	11.5" / 290mm
Color /Finish	Polished	Thickness	0.236" / 6mm
Bobbins	10	Bore	2.22" / 56.4mm
F/R	Rear	Bolt Holes	Counterbored

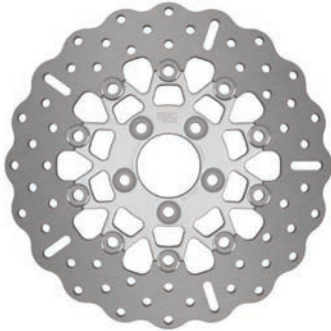

RSD018C
Fits EBC Pads: 387, 400, 434, 458, 710

Type	Floating	OD	11.5" / 290mm
Color /Finish	Polished	Thickness	0.236" / 6mm
Bobbins	10	Bore	2.22" / 56.4mm
F/R	Rear	Bolt Holes	Counterbored

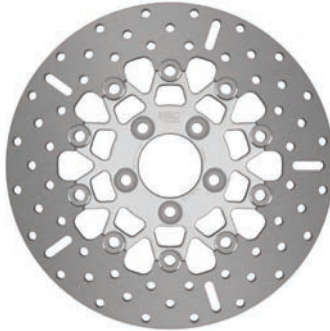

RSD020
Fits EBC Pads: 387, 400, 434, 458, 710

Type	Solid	OD	11.5" / 290mm
Color /Finish	Natural	Thickness	0.236" / 6mm
Bobbins	None	Bore	2.22" / 56.4mm
F/R	Rear	Bolt Holes	Counterbored



RSD008
Fits EBC Pads: 387, 400, 434, 458, 710

Type	Floating	OD	11.5" / 290mm
Color /Finish	Black	Thickness	0.236" / 6mm
Bobbins	10	Bore	2.22" / 56.4mm
F/R	Rear	Bolt Holes	Counterbored



RSD018CBLK
Fits EBC Pads: 387, 400, 434, 458, 710

Type	Floating	OD	11.5" / 290mm
Color /Finish	Black	Thickness	0.236" / 6mm
Bobbins	10	Bore	2.22" / 56.4mm
F/R	Rear	Bolt Holes	Counterbored



RSD020BLK
Fits EBC Pads: 387, 400, 434, 458, 710

Type	Floating	OD	11.5" / 290mm
Color /Finish	Black	Thickness	0.236" / 6mm
Bobbins	10	Bore	2.22" / 56.4mm
F/R	Rear	Bolt Holes	Counterbored



VR020BLK
Fits EBC Pads: 387, 400, 434, 458, 710

ROTOR BOLT KITS AVAILABLE	
HBK001	5 bolts in chrome finish 15/16 UNC - Front
HBK002	5 bolts in Black Chrome finish 15/16 UNC - Front
HBK003	5 bolts in chrome finish 7/8 UNC - Rear
HBK004	5 bolts in Black Chrome finish 7/8 UNC - Rear



ROTOR GROUP NO. 004 - REAR. CHOOSE YOUR PREFERRED STYLE:

Type	Solid	OD	11.5" / 290mm
Color /Finish	Natural	Thickness	0.236" / 6mm
Bobbins	None	Bore	1.99" / 50.6mm
F/R	Rear	Bolt Holes	Counterbored

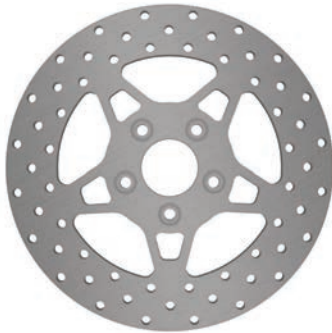

RSD007

Fits EBC Pads: 200, 216/3

Type	Floating	OD	11.5" / 290mm
Color /Finish	Polished	Thickness	0.236" / 6mm
Bobbins	10	Bore	1.99" / 50.6mm
F/R	Rear	Bolt Holes	Counterbored

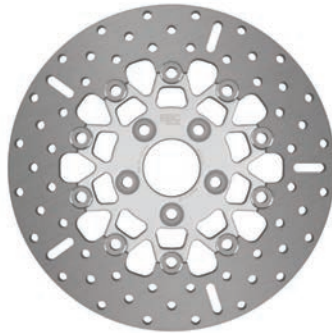

RSD019

Fits EBC Pads: 200, 216/3

Type	Floating	OD	11.5" / 290mm
Color /Finish	Black	Thickness	0.236" / 6mm
Bobbins	10	Bore	1.99" / 50.6mm
F/R	Rear	Bolt Holes	Counterbored



RSD019BLK

Fits EBC Pads: 200, 216/3

Type	Floating	OD	11.5" / 290mm
Color /Finish	Black	Thickness	0.236" / 6mm
Bobbins	10	Bore	1.99" / 50.6mm
F/R	Rear	Bolt Holes	Counterbored



RSD017CBLK

Fits EBC Pads: 200, 216/3

Type	Floating	OD	11.5" / 290mm
Color /Finish	Polished	Thickness	0.236" / 6mm
Bobbins	10	Bore	1.99" / 50.6mm
F/R	Rear	Bolt Holes	Counterbored

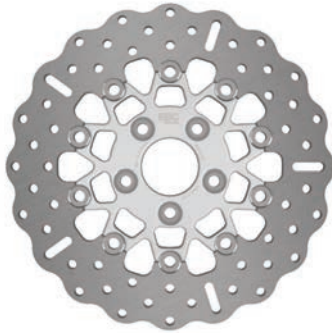

RSD019C

Fits EBC Pads: 200, 216/3

Type	Floating	OD	11.5" / 290mm
Color /Finish	Black	Thickness	0.236" / 6mm
Bobbins	10	Bore	1.99" / 50.6mm
F/R	Rear	Bolt Holes	Counterbored



VR019BLK

Fits EBC Pads: 200, 216/3

MD509SR

Type	Solid	OD	10.67" / 271mm
Color /Finish	Natural	Thickness	0.314" / 8mm
Bobbins	None	Bore	4" / 101.8mm
F/R	Rear	Bolt Holes	Plain



MD509SR – Billet Steel

Fits EBC Pads: 201, 201V only

MD511

Type	Solid	OD	9.44" / 240mm
Color /Finish	Natural	Thickness	0.196" / 5mm
Bobbins	None	Bore	4.13" / 105mm
F/R	Rear	Bolt Holes	Countersunk



MD511
Fits EBC Pads: 140, 251

ROTOR BOLT KITS AVAILABLE

HBK001	5 bolts in chrome finish 15/16 UNC - Front
HBK002	5 bolts in Black Chrome finish 15/16 UNC - Front
HBK003	5 bolts in chrome finish 7/8 UNC - Rear
HBK004	5 bolts in Black Chrome finish 7/8 UNC - Rear



ROTOR GROUP NO. 006 – FRONT/REAR. CHOOSE YOUR PREFERRED STYLE:

Type	Solid	OD	11.5" / 290mm
Color /Finish	Natural	Thickness	0.196" / 5mm
Bobbins	None	Bore	6.77" / 172mm
F/R	F/R	Bolt Holes	N/A

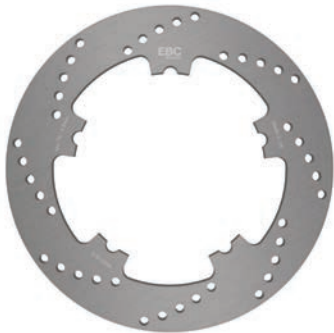

MD514LS
Fits EBC Pads: 400

Type	Solid	OD	11.5" / 290mm
Color /Finish	Natural	Thickness	0.196" / 5mm
Bobbins	None	Bore	6.77" / 172mm
F/R	F/R	Bolt Holes	N/A

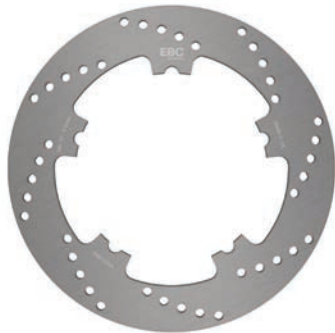

MD514RS
Fits EBC Pads: 400

Type	Solid	OD	11.5" / 290mm
Color /Finish	Natural	Thickness	0.196" / 5mm
Bobbins	None	Bore	6.77" / 172mm
F/R	F/R	Bolt Holes	N/A



VR514
Fits EBC Pads: 400

MD515

Type	Solid	OD	11.5" / 290mm
Color /Finish	Natural	Thickness	0.236" / 6mm
Bobbins	None	Bore	4" / 101.4mm
F/R	Rear	Bolt Holes	Counterbored

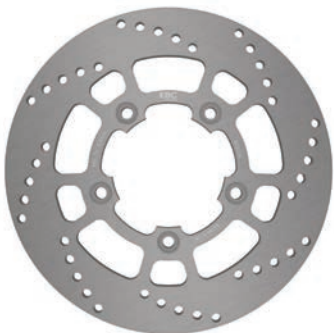

MD515
Fits EBC Pads: 400

ROTOR GROUP NO. 007 - FRONT. CHOOSE YOUR PREFERRED STYLE:

Type	Solid	OD	11.8" / 300mm
Color /Finish	Natural	Thickness	0.196" / 5mm
Bobbins	None	Bore	6.7" / 171mm
F/R	Front	Bolt Holes	N/A

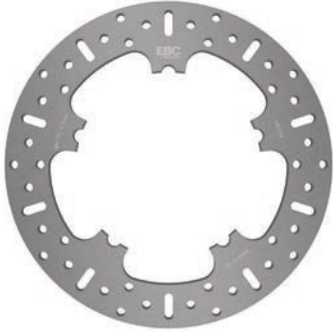

MD516
Fits EBC Pads: 400, 409, 457

Type	Floating	OD	11.8" / 300mm
Color /Finish	Polished	Thickness	0.196" / 5mm
Bobbins	5	Bore	6.7" / 171mm
F/R	Front	Bolt Holes	N/A

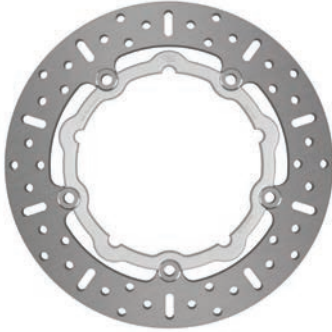

MD516X
Fits EBC Pads: 400, 409, 457

Type	Floating	OD	14" / 355mm
Color /Finish	Black	Thickness	0.196" / 5mm
Bobbins	5	Bore	6.7" / 171mm
F/R	Front	Bolt Holes	N/A

OVERSIZE ROTOR OPTION



OSMD516-14BLK
Fits EBC Pads: 400, 409, 457



Supplied with relocation bracket & hardware
BRK703 **BRK704**

Type	Floating	OD	15" / 381mm
Color /Finish	Black	Thickness	0.196" / 5mm
Bobbins	5	Bore	6.7" / 171mm
F/R	Front	Bolt Holes	N/A

OVERSIZE ROTOR OPTION

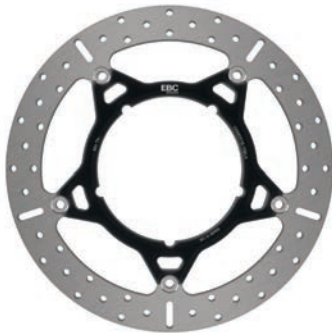

OSMD516-15BLK
Fits EBC Pads: 400, 409, 457



Supplied with relocation bracket & hardware
BRK707 **BRK708**

Increased stopping power, feel and control with the EBC FULLY floating oversize range. These kits bolt directly onto your bike using the stock caliper and also deliver the advantages of a floating rotor over solid designs.

ROTOR GROUP NO. 008 - REAR. CHOOSE YOUR PREFERRED STYLE:

Type	Solid	OD	11.8" / 300mm
Color /Finish	Natural	Thickness	0.275" / 7mm
Bobbins	None	Bore	4" / 101.6mm
F/R	Rear	Bolt Holes	Counterbored



MD517
Fits EBC Pads: 409

Type	Floating	OD	11.8" / 300mm
Color /Finish	Polished	Thickness	0.275" / 7mm
Bobbins	9	Bore	4" / 101.6mm
F/R	Rear	Bolt Holes	Counterbored

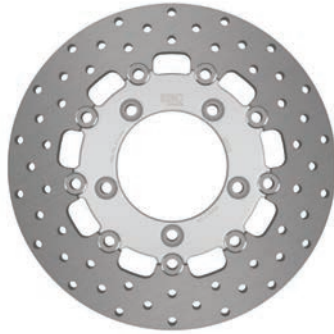

MD525
Fits EBC Pads: 409

ROTOR GROUP NO. 009 – REAR. CHOOSE YOUR PREFERRED STYLE:

Type	Solid	OD	11.8" / 300mm
Color /Finish	Natural	Thickness	0.275" / 7mm
Bobbins	None	Bore	2.22" / 56.4mm
F/R	Rear	Bolt Holes	Counterbored

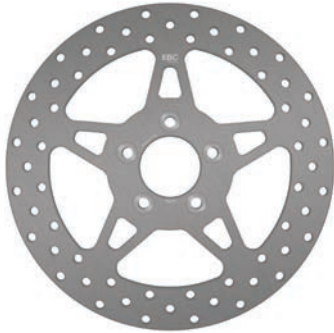

MD542
Fits EBC Pads: 409

Type	Floating	OD	11.8" / 300mm
Color /Finish	Polished	Thickness	0.275" / 7mm
Bobbins	10	Bore	2.22" / 56.4mm
F/R	Rear	Bolt Holes	Counterbored

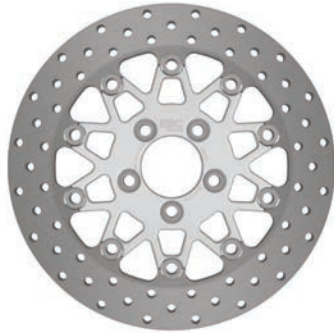

MD521
Fits EBC Pads: 409

Type	Floating	OD	11.8" / 300mm
Color /Finish	Black	Thickness	0.275" / 7mm
Bobbins	10	Bore	2.22" / 56.4mm
F/R	Rear	Bolt Holes	Counterbored



MD521BLK
Fits EBC Pads: 409

Type	Floating	OD	11.8" / 300mm
Color /Finish	Black	Thickness	0.275" / 7mm
Bobbins	10	Bore	2.22" / 56.4mm
F/R	Rear	Bolt Holes	Counterbored



VR521BLK
Fits EBC Pads: 409

ROTOR BOLT KITS AVAILABLE

HBK001	5 bolts in chrome finish 15/16 UNC - Front
HBK002	5 bolts in Black Chrome finish 15/16 UNC - Front
HBK003	5 bolts in chrome finish 7/8 UNC - Rear
HBK004	5 bolts in Black Chrome finish 7/8 UNC - Rear



ROTOR GROUP NO. 010 - FRONT. CHOOSE YOUR PREFERRED STYLE:

Type	Floating	OD	11.8" / 300mm
Color /Finish	Polished	Thickness	0.196" / 5mm
Bobbins	10	Bore	2.22" / 56.4mm
F/R	Front	Bolt Holes	Counterbored

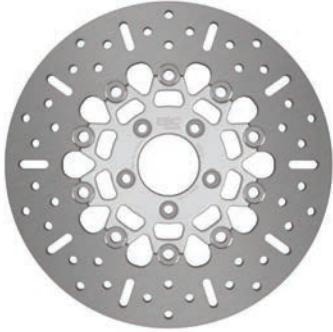

MD518
Fits EBC Pads: 400, 409, 457

Type	Floating	OD	11.8" / 300mm
Color /Finish	Black	Thickness	0.196" / 5mm
Bobbins	10	Bore	2.22" / 56.4mm
F/R	Front	Bolt Holes	Counterbored



MD518BLK
Fits EBC Pads: 400, 409, 457

Type	Floating	OD	11.8" / 300mm
Color /Finish	Black	Thickness	0.196" / 5mm
Bobbins	10	Bore	2.22" / 56.4mm
F/R	Front	Bolt Holes	Counterbored



MD518CBLK
Fits EBC Pads: 400, 409, 457

Type	Floating	OD	11.8" / 300mm
Color /Finish	Black	Thickness	0.196" / 5mm
Bobbins	10	Bore	2.22" / 56.4mm
F/R	Front	Bolt Holes	Plain



MD520/10BLK
Fits EBC Pads: 409

Type	Floating	OD	11.8" / 300mm
Color /Finish	Polished	Thickness	0.196" / 5mm
Bobbins	5	Bore	2.22" / 56.4mm
F/R	Front	Bolt Holes	Plain

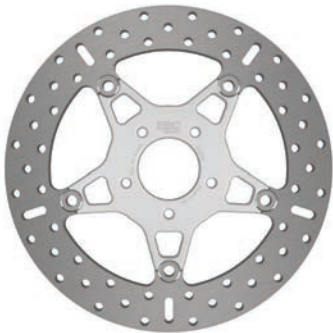

MD520
Fits EBC Pads: 296, 409, 638, 640

Type	Floating	OD	11.8" / 300mm
Color /Finish	Natural	Thickness	0.196" / 5mm
Bobbins	None	Bore	2.22" / 56.4mm
F/R	Front	Bolt Holes	Plain



VR520BLK
Fits EBC Pads: 409

Type	Solid	OD	11.8" / 300mm
Color /Finish	Natural	Thickness	0.196" / 5mm
Bobbins	None	Bore	2.22" / 56.4mm
F/R	Front	Bolt Holes	Counterbored



MD526
Fits EBC Pads: 296, 640

Type	Floating	OD	11.8" / 300mm
Color /Finish	Polished	Thickness	0.196" / 5mm
Bobbins	5	Bore	2.22" / 56.4mm
F/R	Front	Bolt Holes	Counterbored

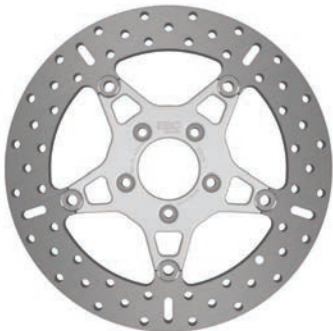

MD530
Fits EBC Pads: 296, 409, 638, 640

Type	Floating	OD	11.8" / 300mm
Color /Finish	Black	Thickness	0.196" / 5mm
Bobbins	5	Bore	2.22" / 56.4mm
F/R	Front	Bolt Holes	Counterbored



MD530BLK
Fits EBC Pads: 296, 638, 640

Type	Solid	OD	11.8" / 300mm
Color /Finish	Natural	Thickness	0.196" / 5mm
Bobbins	None	Bore	2.22" / 56.4mm
F/R	Front	Bolt Holes	Plain



MD541
Fits EBC Pads: 409

5 button or 10 button Floating Rotors

Light duty 5 button rotors are designed for bikes with a TWIN front rotor set up.
Heavy duty 10 button rotors are designed for bikes with a SINGLE front rotor set up.

ROTOR GROUP NO. 010 - FRONT. CHOOSE YOUR PREFERRED STYLE:

Type	Floating	OD	14" / 355mm
Color /Finish	Polished	Thickness	0.196" / 5mm
Bobbins	5	Bore	2.22" / 56.4mm
F/R	Front	Bolt Holes	Counterbored

OVERSIZE ROTOR OPTION

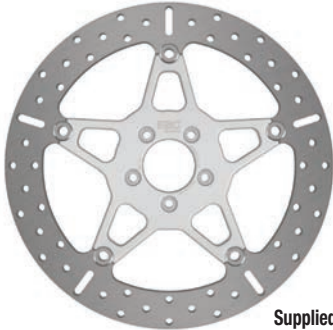

OSMD518-14
Fits EBC Pads: 400, 409, 457
BRK701 SEE RIGHT

Type	Floating	OD	14" / 355mm
Color /Finish	Black	Thickness	0.196" / 5mm
Bobbins	5	Bore	2.22" / 56.4mm
F/R	Front	Bolt Holes	Counterbored

OVERSIZE ROTOR OPTION

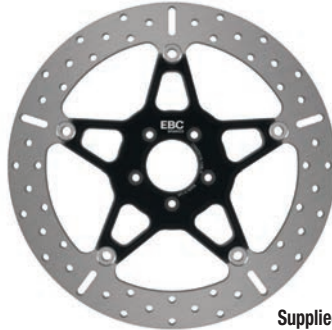

OSMD518-14BLK
Fits EBC Pads: 400, 409, 457
BRK701 SEE RIGHT

Increased stopping power, feel and control with the EBC FULLY floating oversize range. These kits bolt directly onto your bike using the stock caliper and also deliver the advantages of a floating rotor over solid designs.



BRK701

Supplied with relocation bracket & hardware

Supplied with relocation bracket & hardware

MD522

Type	Solid	OD	9.44" / 240mm
Color /Finish	Natural	Thickness	0.196" / 5mm
Bobbins	None	Bore	2.77" / 70.6mm
F/R	Rear	Bolt Holes	Plain

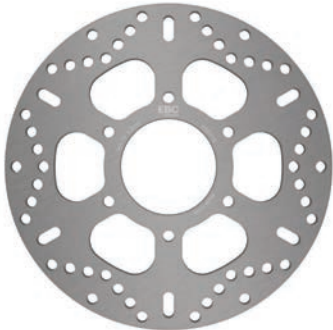

MD522
Fits EBC Pads: 140

ROTOR BOLT KITS AVAILABLE

HBK001	5 bolts in chrome finish 15/16 UNC - Front
HBK002	5 bolts in Black Chrome finish 15/16 UNC - Front
HBK003	5 bolts in chrome finish 7/8 UNC - Rear
HBK004	5 bolts in Black Chrome finish 7/8 UNC - Rear



ROTOR GROUP NO. 011 – REAR. CHOOSE YOUR PREFERRED STYLE:

Type	Solid	OD	10.23" / 260mm
Color /Finish	Natural	Thickness	0.275" / 7mm
Bobbins	None	Bore	2.22" / 56.4mm
F/R	Rear	Bolt Holes	Counterbored



MD524
Fits EBC Pads: 254, 387

Type	Floating	OD	10.23" / 260mm
Color /Finish	Polished	Thickness	0.275" / 7mm
Bobbins	10	Bore	2.22" / 56.4mm
F/R	Rear	Bolt Holes	Counterbored

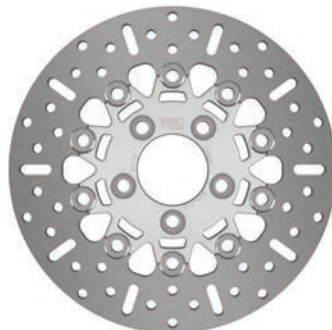

RSD524
Fits EBC Pads: 254, 387

ROTOR GROUP NO. 017 – FRONT. CHOOSE YOUR PREFERRED STYLE:

Type	Solid	OD	11.8" / 300mm
Color /Finish	Natural	Thickness	0.196" / 5mm
Bobbins	None	Bore	5.48" / 139.2mm
F/R	Front	Bolt Holes	N/A

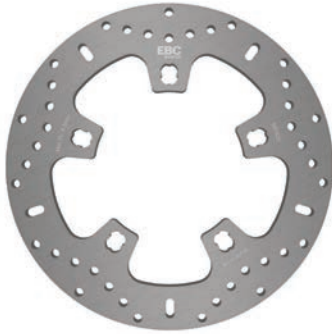

MD529
Fits EBC Pads: 409

Type	Solid	OD	11.8" / 300mm
Color /Finish	Natural	Thickness	0.196" / 5mm
Bobbins	None	Bore	5.48" / 139.2mm
F/R	Front	Bolt Holes	N/A



VR529
Fits EBC Pads: 409

MD531

MD532

Type	Solid	OD	11.5" / 290mm
Color /Finish	Natural	Thickness	0.196" / 5mm
Bobbins	None	Bore	2.22" / 56.4mm
F/R	Front	Bolt Holes	Plain



MD531
Fits EBC Pads: 643

Type	Solid	OD	10.23" / 260mm
Color /Finish	Natural	Thickness	0.196" / 5mm
Bobbins	None	Bore	2.22" / 56.4mm
F/R	Rear	Bolt Holes	Plain



MD532
Fits EBC Pads: 643

ROTOR GROUP NO. 019 – FRONT/REAR. CHOOSE YOUR PREFERRED STYLE:

Type	Solid	OD	11.8" / 300mm
Color /Finish	Black	Thickness	0.82" / 21mm
Bobbins	None	Bore	2.67" / 68mm
F/R	F/R	Bolt Holes	Plain



MD533BSDF – Front 2 required
Fits EBC Pads: 669/4, 670

Type	Solid	OD	11.8" / 300mm
Color /Finish	Black	Thickness	0.82" / 21mm
Bobbins	None	Bore	2.67" / 68mm
F/R	F/R	Bolt Holes	Plain



MD533BSDR – Rear 1 required
Fits EBC Pads: 669/4, 670

BSDF and BSDR slotted sport rotors
choose axle required from suffix F for front
and R for rear)

ROTOR GROUP NO. 020 – FRONT/REAR. CHOOSE YOUR PREFERRED STYLE:

Type	Solid	OD	11.73" / 298mm
Color /Finish	Natural	Thickness	0.196" / 5mm
Bobbins	None	Bore	2.52" / 64.2mm
F/R	F/R	Bolt Holes	Plain



MD534
Fits EBC Pads: 209/2, 213, 377, 672

Type	Floating	OD	11.73" / 298mm
Color /Finish	Polished	Thickness	0.196" / 5mm
Bobbins	10	Bore	2.52" / 64.2mm
F/R	F/R	Bolt Holes	Plain

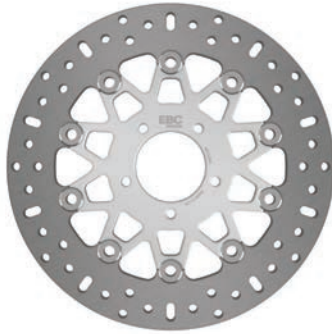

MD534X
Fits EBC Pads: 209/2, 213, 377, 672

Type	Floating	OD	11.73" / 298mm
Color /Finish	Polished	Thickness	0.196" / 5mm
Bobbins	10	Bore	2.52" / 64.2mm
F/R	F/R	Bolt Holes	Plain



MD534XBLK
Fits EBC Pads: 209/2, 213, 377, 672

ROTOR GROUP NO. 021 - FRONT/REAR. CHOOSE YOUR PREFERRED STYLE:

Type	Floating	OD	11.5" / 290mm
Color /Finish	Polished	Thickness	0.196" / 5mm
Bobbins	5	Bore	2.22" / 56.4mm
F/R	F/R	Bolt Holes	Counterbored

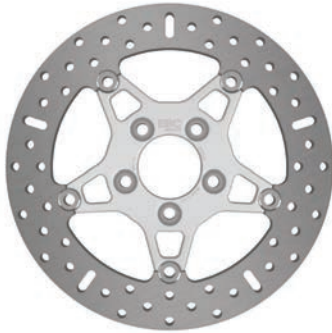

MD535
Fits EBC Pads: 95, 696

Type	Floating	OD	11.5" / 290mm
Color /Finish	Black	Thickness	0.196" / 5mm
Bobbins	5	Bore	2.22" / 56.4mm
F/R	F/R	Bolt Holes	Counterbored



MD535BLK
Fits EBC Pads: 95, 696

ROTOR GROUP NO. 022 – FRONT. CHOOSE YOUR PREFERRED STYLE:

Type	Solid	OD	11.8" / 300mm
Color /Finish	Natural	Thickness	0.236" / 6mm
Bobbins	None	Bore	2.22" / 56.4mm
F/R	Front	Bolt Holes	Counterbored



MD536
Fits EBC Pads: 209/2

Type	Floating	OD	11.8" / 300mm
Color /Finish	Polished	Thickness	0.236" / 6mm
Bobbins	5	Bore	2.22" / 56.4mm
F/R	Front	Bolt Holes	Counterbored

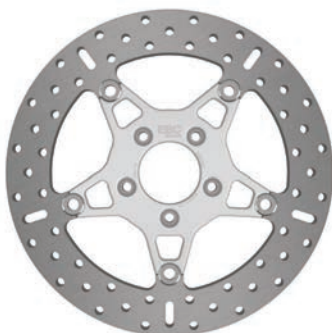

MD536X
Fits EBC Pads: 209/2

Type	Floating	OD	11.8" / 300mm
Color /Finish	Black	Thickness	0.236" / 6mm
Bobbins	5	Bore	2.22" / 56.4mm
F/R	Front	Bolt Holes	Counterbored



MD536XBLK
Fits EBC Pads: 209/2

MD537

Type	Solid	OD	11.8" / 300mm
Color /Finish	Natural	Thickness	0.236" / 6mm
Bobbins	None	Bore	2.22" / 56.4mm
F/R	Rear	Bolt Holes	Counterbored



MD537
Fits EBC Pads: 181

ROTOR BOLT KITS AVAILABLE

HBK001	5 bolts in chrome finish 15/16 UNC - Front
HBK002	5 bolts in Black Chrome finish 15/16 UNC - Front
HBK003	5 bolts in chrome finish 7/8 UNC - Rear
HBK004	5 bolts in Black Chrome finish 7/8 UNC - Rear



MD538

Type	Solid	OD	10.67" / 270.5mm
Color /Finish	Black	Thickness	0.236" / 6mm
Bobbins	None	Bore	4.311" / 109.5mm
F/R	Rear	Bolt Holes	Plain



MD538 – Cast iron rotors for Trikes®
Fits EBC Pads: 641/4

MD540

Type	Solid	OD	8.97" / 233mm
Color /Finish	Black	Thickness	0.236" / 6mm
Bobbins	None	Bore	6.783" / 172.3mm
F/R	Rear	Bolt Holes	Plain



MD540 – Cast iron rotors for Trikes®
Fits EBC Pads: 605/4

ROTOR GROUP NO. 024 - FRONT/REAR. CHOOSE YOUR PREFERRED STYLE:

Type	Floating	OD	11.8" / 300mm
Color /Finish	Natural	Thickness	0.196" / 5mm
Bobbins	9	Bore	2.52" / 64.2mm
F/R	F/R	Bolt Holes	Plain



MD678
Fits EBC Pads: 196, 209/2, 244, 347

Type	Floating	OD	11.8" / 300mm
Color /Finish	Black	Thickness	0.196" / 5mm
Bobbins	9	Bore	2.52" / 64.2mm
F/R	F/R	Bolt Holes	Plain



MD678BLK
Fits EBC Pads: 196, 209/2, 244, 347

Type	Floating	OD	11.8" / 300mm
Color /Finish	Black	Thickness	0.196" / 5mm
Bobbins	9	Bore	2.52" / 64.2mm
F/R	F/R	Bolt Holes	Plain

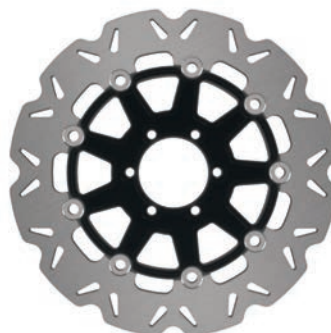

VR678BLK
Fits EBC Pads: 196, 209/2, 244, 347

ROTOR GROUP NO. 025 – REAR. CHOOSE YOUR PREFERRED STYLE:

Type	Floating	OD	11.8" / 300mm
Color /Finish	Black	Thickness	0.275" / 7mm
Bobbins	9	Bore	2.527" / 64.2mm
F/R	Rear	Bolt Holes	Plain



MD887BLK
Fits EBC Pads: 196

Type	Floating	OD	11.8" / 300mm
Color /Finish	Black	Thickness	0.275" / 7mm
Bobbins	9	Bore	2.527" / 64.2mm
F/R	Rear	Bolt Holes	Plain



VR887BLK
Fits EBC Pads: 196

ROTOR GROUP NO. 026 – FRONT/REAR. CHOOSE YOUR PREFERRED STYLE:

Type	Floating	OD	11.8" / 300mm
Color /Finish	Natural	Thickness	0.196" / 5mm
Bobbins	9	Bore	1.99" / 50.6mm
F/R	F/R	Bolt Holes	Plain

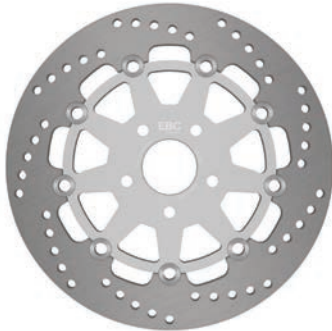

MD727
Fits EBC Pads: 209/2, 244

Type	Floating	OD	11.8" / 300mm
Color /Finish	Black	Thickness	0.196" / 5mm
Bobbins	9	Bore	1.99" / 50.6mm
F/R	F/R	Bolt Holes	Plain

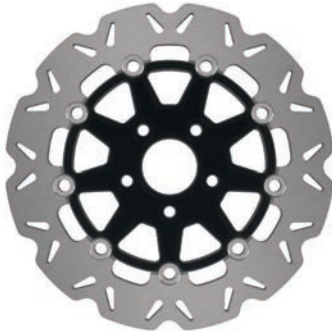

VR727BLK
Fits EBC Pads: 209/2, 244

ROTOR GROUP NO. 027 - FRONT. CHOOSE YOUR PREFERRED STYLE:

Type	Solid	OD	9.84" / 250mm
Color /Finish	Natural	Thickness	0.236" / 6mm
Bobbins	None	Bore	2.606" / 66.2mm
F/R	Front	Bolt Holes	Plain



MD801
Fits EBC Pads: 474

Type	Solid	OD	9.84" / 250mm
Color /Finish	Natural	Thickness	0.236" / 6mm
Bobbins	None	Bore	2.606" / 66.2mm
F/R	Front	Bolt Holes	Plain



VR801
Fits EBC Pads: 474

ROTOR GROUP NO. 028 – REAR. CHOOSE YOUR PREFERRED STYLE:

Type	Solid	OD	9.84" / 250mm
Color /Finish	Natural	Thickness	0.236" / 6mm
Bobbins	None	Bore	2.606" / 66.2mm
F/R	Rear	Bolt Holes	Plain



MD802
Fits EBC Pads: 473

Type	Solid	OD	9.84" / 250mm
Color /Finish	Natural	Thickness	0.236" / 6mm
Bobbins	None	Bore	2.606" / 66.2mm
F/R	Rear	Bolt Holes	Plain



VR802
Fits EBC Pads: 473

ROTOR GROUP NO. 029 – FRONT. CHOOSE YOUR PREFERRED STYLE:

Type	Solid	OD	10.6" / 270mm
Color /Finish	Natural	Thickness	0.275" / 7mm
Bobbins	None	Bore	2.46" / 62.6mm
F/R	Front	Bolt Holes	Plain

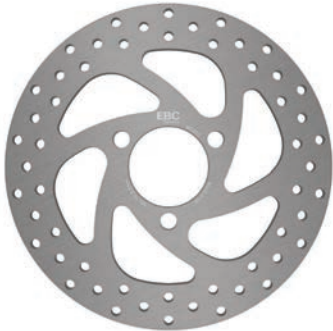

MD853
Fits EBC Pads: 630

Type	Solid	OD	10.6" / 270mm
Color /Finish	Natural	Thickness	0.275" / 7mm
Bobbins	None	Bore	2.46" / 62.6mm
F/R	Front	Bolt Holes	Plain



VR853
Fits EBC Pads: 630

ROTOR GROUP NO. 030 - REAR. CHOOSE YOUR PREFERRED STYLE:

Type	Solid	OD	10.6" / 270mm
Color /Finish	Natural	Thickness	0.275" / 7mm
Bobbins	None	Bore	2.46" / 62.6mm
F/R	Rear	Bolt Holes	Counterbored



MD854
Fits EBC Pads: 631

Type	Solid	OD	10.6" / 270mm
Color /Finish	Natural	Thickness	0.275" / 7mm
Bobbins	None	Bore	2.46" / 62.6mm
F/R	Rear	Bolt Holes	Counterbored



VR854
Fits EBC Pads: 631

ROTOR BOLT KITS AVAILABLE

HBK001	5 bolts in chrome finish 15/16 UNC - Front
HBK002	5 bolts in Black Chrome finish 15/16 UNC - Front
HBK003	5 bolts in chrome finish 7/8 UNC - Rear
HBK004	5 bolts in Black Chrome finish 7/8 UNC - Rear



ROTOR GROUP NO. 031 – FRONT.

ROTOR GROUP NO. 032 – REAR.

Type	Solid	OD	12.59" / 320mm
Color /Finish	Natural	Thickness	0.196" / 5mm
Bobbins	None	Bore	8.86" / 225mm
F/R	Front	Bolt Holes	N/A

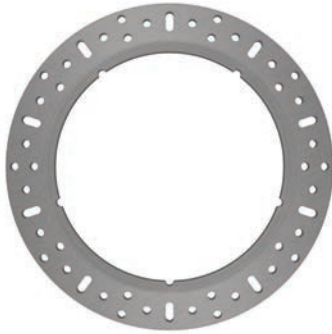

MD737
Fits EBC Pads: 196

Type	Solid	OD	12.59" / 320mm
Color /Finish	Natural	Thickness	0.196" / 5mm
Bobbins	None	Bore	8.86" / 225mm
F/R	Front	Bolt Holes	N/A

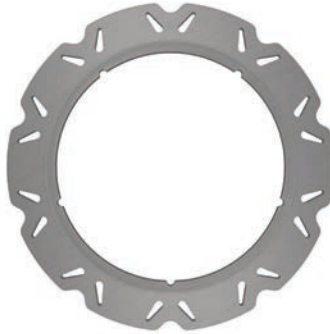

VR737
Fits EBC Pads: 196

Type	Solid	OD	8.66" / 220mm
Color /Finish	Natural	Thickness	0.196" / 5mm
Bobbins	None	Bore	1.99" / 50.6mm
F/R	Rear	Bolt Holes	Plain



MD738
Fits EBC Pads: 140

Type	Solid	OD	8.66" / 220mm
Color /Finish	Natural	Thickness	0.196" / 5mm
Bobbins	None	Bore	1.99" / 50.6mm
F/R	Rear	Bolt Holes	Plain



VR738
Fits EBC Pads: 140

MD689

MD690

MD690C

MD691

Type	Solid	OD	9.05" / 230mm
Color /Finish	Natural	Thickness	0.177" / 4.5mm
Bobbins	None	Bore	3.433" / 87.2mm
F/R	Rear	Bolt Holes	Counterbored

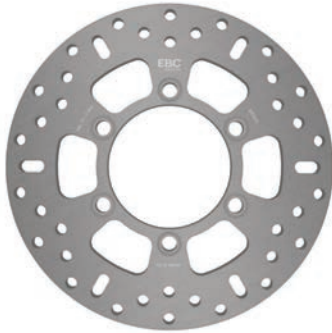

MD689
Fits EBC Pads: 86

Type	Floating	OD	11.8" / 300mm
Color /Finish	Natural	Thickness	0.157" / 4mm
Bobbins	9	Bore	2.527" / 64.2mm
F/R	Front	Bolt Holes	Counterbored

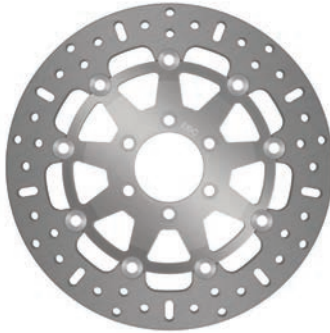

MD690
Fits EBC Pads: 86

Type	Floating	OD	11.8" / 300mm
Color /Finish	Natural	Thickness	0.157" / 4mm
Bobbins	9	Bore	2.527" / 64.2mm
F/R	Front	Bolt Holes	Counterbored

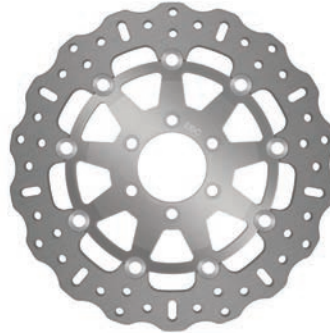

MD690C
Fits EBC Pads: 86

Type	Floating	OD	11.8" / 300mm
Color /Finish	Natural	Thickness	0.157" / 4mm
Bobbins	6	Bore	5.126" / 130.2mm
F/R	Front	Bolt Holes	Counterbored

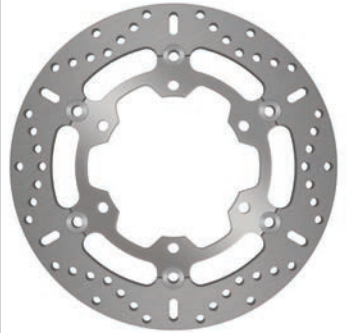

MD691
Fits EBC Pads: 86

MD719RS

MD734RS

MD735RS

MD803

Type	Floating	OD	13.38" / 340mm
Color /Finish	Natural	Thickness	0.196" / 5mm
Bobbins	9	Bore	2.385" / 60.6mm
F/R	Front	Bolt Holes	Countersunk



MD719RS
Fits EBC Pads: 210, 424

Type	Floating	OD	13.38" / 340mm
Color /Finish	Natural	Thickness	0.196" / 5mm
Bobbins	9	Bore	2.385" / 60.6mm
F/R	Front	Bolt Holes	Counterbored



MD734RS
Fits EBC Pads: 424

Type	Solid	OD	14.76" / 375mm
Color /Finish	Natural	Thickness	0.196" / 5mm
Bobbins	None	Bore	12" / 307mm
F/R	Front	Bolt Holes	N/A

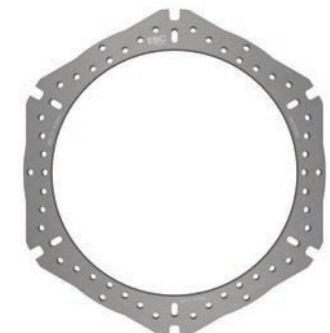

MD735RS
Fits EBC Pads: 345, 454/4

Type	Solid	OD	12.6" / 320mm
Color /Finish	Natural	Thickness	0.177" / 4.5mm
Bobbins	None	Bore	7.106" / 180.5mm
F/R	Front	Bolt Holes	Plain

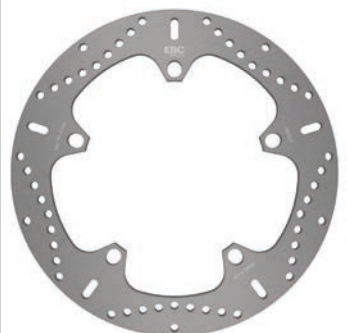

MD803
Fits EBC Pads: 630

MD890BLK

MD8007

MD1187C

MD6435C

Type	Floating	OD	11.8" / 300mm
Color /Finish	Black	Thickness	0.196" / 5mm
Bobbins	9	Bore	2.527" / 64.2mm
F/R	Front	Bolt Holes	Plain



MD890BLK
Fits EBC Pads: 196, 261, 347

Type	Solid	OD	10.24" / 260mm
Color /Finish	Natural	Thickness	0.196" / 5mm
Bobbins	None	Bore	4.63" / 117.6mm
F/R	Rear	Bolt Holes	Plain

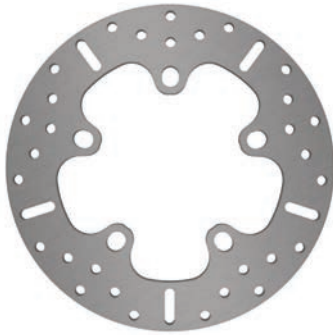

MD8007
Fits EBC Pads: 266

Type	Solid	OD	12.6" / 320mm
Color /Finish	Natural	Thickness	0.196" / 5mm
Bobbins	None	Bore	8.35" / 212.2mm
F/R	Front	Bolt Holes	Plain

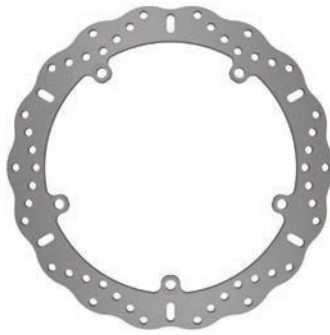

MD1187C
Fits EBC Pads: 185, 209/2, 264

Type	Solid	OD	9.44" / 240mm
Color /Finish	Natural	Thickness	0.157" / 4mm
Bobbins	None	Bore	4.141" / 105.2mm
F/R	Front	Bolt Holes	Plain

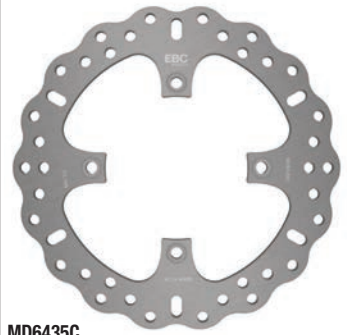

MD6435C
Fits EBC Pads: 83, 181, 185, 208, 209/2, 213, 264, 367

MD8018XBLK

MD8019

Type	Floating	OD	12.59" / 320mm
Color /Finish	Black	Thickness	0.177" / 4.5mm
Bobbins	5	Bore	2.244" / 57mm
F/R	Front	Bolt Holes	Plain



MD8018XBLK
Fits EBC Pads: 630

Type	Solid	OD	11.02" / 280mm
Color /Finish	Natural	Thickness	0.196" / 5mm
Bobbins	None	Bore	6.614" / 168mm
F/R	Rear	Bolt Holes	Plain

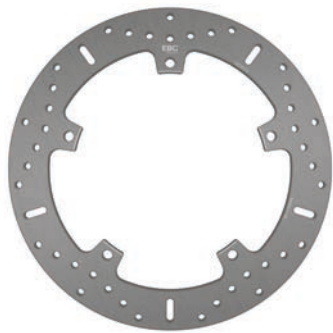

MD8019
Fits EBC Pads: 213

ROTOR BOLT KITS AVAILABLE

HBK001	5 bolts in chrome finish 15/16 UNC - Front
HBK002	5 bolts in Black Chrome finish 15/16 UNC - Front
HBK003	5 bolts in chrome finish 7/8 UNC - Rear
HBK004	5 bolts in Black Chrome finish 7/8 UNC - Rear



MD8020

MD8030

MD8031

Type	Solid	OD	12.59" / 320mm
Color /Finish	Natural	Thickness	0.177" / 4.5mm
Bobbins	None	Bore	6.322" / 160.6mm
F/R	Front	Bolt Holes	Elliptical

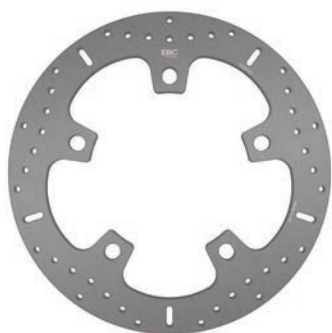

MD8020
Fits EBC Pads: 630

Type	Solid	OD	12.59" / 320mm
Color /Finish	Natural	Thickness	0.236" / 6mm
Bobbins	None	Bore	6.692" / 170mm
F/R	Front	Bolt Holes	Elliptical

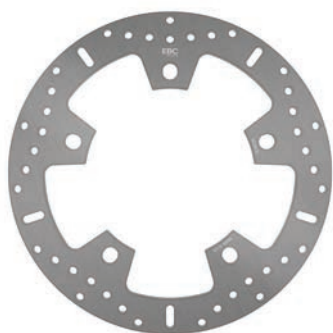

MD8030
Fits EBC Pads: 630

Need more braking power without going oversize



The EBC EPFA range have higher friction and therefore braking power and would be a great first attempt to boost brakes on a machine that lacks braking power at the front end.

Type	Solid	OD	10.24" / 260mm
Color /Finish	Natural	Thickness	0.196" / 5mm
Bobbins	None	Bore	5.315" / 135mm
F/R	Rear	Bolt Holes	Plain

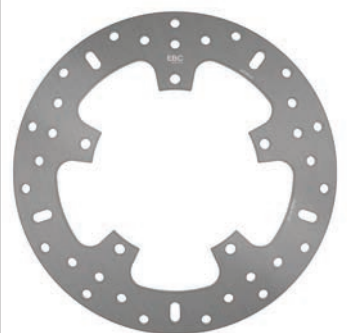

MD8031
Fits EBC Pads: 760

BRAKE LINES

EBC Brakes braided brake lines are manufactured in Great Britain from the highest quality materials, with braided stainless steel PTFE hose and grade 303 stainless steel precision machined fittings. At EBC Brakes we do not use mild steel or aluminum components in our brake lines, instead we choose stainless steel for every fitting, as this material offers maximum quality in terms of strength and corrosion resistance. EBC brake line kits are supplied 100% complete and include brand new stainless steel bolts and copper washers for maximum visuals.

EBC Brakes braided hoses fit many bikes in front, rear and race designs. Braided hoses improve brake pressure transfer to the caliper and Rotor pads, they help improve lever feel and reduce “bulging” which may happen with standard rubber hoses. Braided hoses are also more resistant to abrasion or cuts common with off road riding and thereby improve safety.

EBC brake lines are designed and built to last, that’s why every line is offered with a lifetime warranty. Every individual line is pressure tested after assembly and as an absolute guarantee of quality, EBC brake lines are manufactured to Federal Motor Vehicle Safety Standards (FMVSS-106) and have the following approvals: DOT, TÜV, ISO9001, DEKRA, ARAI, CCC AND ADR.

CAUTION – Check hose lengths carefully against parts being replaced and check carefully for pinch points and that hoses are not stretched at full handlebar lock position as this could cause hose leak and brake failure and an accident. EBC hoses are meant to replace standard length hoses and if your customer has changed to different size and shape bars these lines WILL NOT FIT and custom lines must be sourced.



KBA 61169

ISO9001



DEKRA

ARAI



ADR

BLM is our standard braided hose series.

Hose numbers are suffixed with a number and letter designating the number of hoses in the kits and front or rear, for example;

BLM5000-1F is a kit with a single hose for front fitment

BLM5007-3F is a kit with three hoses for front fitment

BLM5002-2R is a kit with two hoses for rear fitment

HARLEY-DAVIDSON® BRAKE LINES

EBC Harley-Davidson® lines are supplied in a unique finish, with chromed stainless fittings, black hose and black/space-grey EBC Brakes heat shrink.

Additionally, where many competitors use ‘off the shelf’ components, EBC Harley-Davidson® lines are manufactured using our own bespoke design of chrome plated hardware and brackets, ensuring perfect fitment for complex Harley-Davidson® brake line assemblies.



BRAKE LINES



HARLEY-DAVIDSON®



		OE Replacement Brake Lines (Front)	OE Replacement Brake Lines (Rear)
DYNA			
FLD Switchback	2012-2014	BLM5000-1F	
FLH/FLT Except FLTR ABS	2009-2013	BLM5001-4F	
FLH/FLT	1992-1996		BLM5002-2R
FLH/FLT	1997-2007		BLM5003-2R
FLH/FLT	2008-2013		BLM5004-1R
FLH/FLT	2009-2013	BLM5005-1F	
FLH/FLT	2014-2016	BLM5006-1F	
FLH/FLT	2008-2013	BLM5007-3F	
FXD	1991-1999		BLM5049-2R
FXD	2000-2007		BLM5050-2R
FXD	2008-2013		BLM5051-1R
FXD/FXDC	2000-2005	BLM5052-1F	
FXD35 35th Anniversary	2006-2007	BLM5053-1F	
FXDB Dyna Daytona	1991-1992	BLM5054-3F	
FXDB-S Sturgis	1991-1992	BLM5055-1F	
FXDBI Street Bob	2006-2015	BLM5056-1F	
FXDC	2006-2014	BLM5057-1F	
FXDC Dyna Glide Custom	1990-1992	BLM5058-1F	
FXDC Dyna Glide Custom	1991-1992	BLM5054-3F	
FXDC/FXDCI Dyna Super Glide	2005	BLM5052-1F	
FXDF Dyna Fat Bob	2008-2015	BLM5061-3F	
FXDL Dyna Low Rider	1993-2000	BLM5054-3F	
FXDL Dyna Low Rider	2001-2005	BLM5063-1F	
FXDL Dyna Low Rider	2006-2013	BLM5000-1F	
FXDS-Con Dyna Low Rider Convertible	1993-2000	BLM5054-3F	
FXDWG Dyna Wide Glide	1993-2005	BLM5066-1F	
FXDWG Dyna Wide Glide	2006-2008	BLM5067-1F	
FXDWG Dyna Wide Glide	2010-2014	BLM5068-1F	
FXDX Super Glide Sport	1999-2005	BLM5069-3F	
FXDXT Dyna Super Glide	2001-2003	BLM5070-3F	
FXLR/FXR	1987-1994		BLM5071-2R
FXLR Low Rider Custom Low Bars	1987-1994	BLM5072-1F	
FXR Super Glide	1987-1994	BLM5052-1F	
FXRS Low Rider Custom	1987-1994	BLM5074-1F	
FXRS-C Low Rider Convertible	1987-1994	BLM5075-3F	
FXRS-SP Low Rider Sport	1987-1994	BLM5076-3F	
FXRT Sport Glide Tourer	1987-1992	BLM5077-3F	
SOFTAIL			
FLS Softail Slim	2013-2015	BLM5018-1F	
FLS Softail Slim	2017-2018	BLM5120-1F	
FLST	2008-2013		BLM5019-2R
FLST Fat Boy	1984-1999		BLM5020-2R
FLST Fat Boy	2000-2006		BLM5021-2R
FLST Heritage	1984-1990	BLM5022-1F	
FLST Heritage	2007		BLM5023-2R
FLST-SB Cross Bones	2010-2011	BLM5024-1F	
FLSTC	2011-2015	BLM5025-1F	
FLSTC Heritage Classic	2011-2015	BLM5026-2F	
FLSTC Heritage Softail Classic	1987-2008	BLM5022-1F	
FLSTC Heritage Softail Classic	2009-2012	BLM5028-1F	
FLSTF	2011	BLM5029-1F	

FRONT

REAR

BRAKE LINES



HARLEY-DAVIDSON®



		OE Replacement Brake Lines (Front)	OE Replacement Brake Lines (Rear)
FLSTF Fat Boy	1990-2011	BLM5022-1F	
FLSTF Fat Boy	2007		BLM5031-2R
FLSTF Fatboy	2011	BLM5032-2F	
FLSTF/FLSTFB/FLSTF	2012-2013	BLM5018-1F	
FLSTF/FLSTN/FLSTB/FLS ABS	2012-2016	BLM5034-1F	
FLSTF/FLSTN/FLSTFB/FLS ABS	2012-2016	BLM5035-2F	
FLSTFB ABS	2011	BLM5036-1F	
FLSTFB Fatboy Low ABS	2011	BLM5037-2F	
FLSTN Softail Deluxe	2005-2013	BLM5018-1F	
FLSTN Softail Deluxe ABS	2011-2012	BLM5035-2F	
FLSTS Heritage Softail	1997-2003	BLM5040-1F	
FLSTSC Heritage Softail Classic	2005-2007	BLM5041-1F	
FXCW/FXCWC Softail Rocker	2008-2011	BLM5046-1F	
FXCWC ABS	2011	BLM5047-1F	
FXCWC Rocker ABS	2011	BLM5048-2F	
FXS Blackline	2011-2013	BLM5078-1F	
FXSB Breakout ABS	2014-2015	BLM5079-1F	
FXSB Breakout	2011-2014	BLM5127-3F	
FXSB Breakout	2015-2017	BLM5128-3F	
FXST	1984-1999		BLM5080-2R
FXST	2000-2005		BLM5021-2R
FXST ABS	2011-2015	BLM5082-1F	
FXST Softail	1984-1990	BLM5083-1F	
FXST Softail Standard	1999-2012	BLM5083-1F	
FXST/FXCW	2008-2013		BLM5019-2R
FXST/FXSTB/FXSTC	2007		BLM5031-2R
FXST/FXSTS/FXSTB	2006		BLM5087-2R
FXSTB Softail Night Train	1999-2009	BLM5088-1F	
FXSTC Softail Custom	1987-1999	BLM5083-1F	
FXSTC Softail Custom	2007-2010	BLM5090-1F	
FXSTD	2000-2006		BLM5021-2R
FXSTD	2007		BLM5023-2R
FXSTD Deuce	2000-2007	BLM5093-1F	
FXSTS Springer Softail	1987-2006	BLM5094-1F	
FXSTSB Bad Boy	1995-1997	BLM5095-1F	
SPORTSTER			
XL 50	2007	BLM5112-1F	BLM5105-2R
XL All Models	2004-2013		BLM5105-2R
XL All Models	1987-2003		BLM5106-2R
XL 883 Custom	2004-2010	BLM5112-1F	BLM5105-2R
XL 883 Custom	1996-2003	BLM5108-1F	BLM5106-2R
XL 883 Deluxe	1987-1991	BLM5108-1F	BLM5106-2R
XL 883 Deluxe	1992-2003	BLM5111-1F	BLM5106-2R
XL 883 R	2004-2013	BLM5109-3F	BLM5105-2R
XL 883 R	2002-2003	BLM5126-3F	BLM5106-2R
XL 883 Standard	2004-2009	BLM5113-1F	BLM5105-2R
XL 883 Standard	1987-2003	BLM5108-1F	BLM5106-2R
XL 883L Low	2005-2015	BLM5115-1F	
XL 883 N Iron	2010-2013	BLM5113-1F	BLM5105-2R
XL 883 N Iron	2014-2015	BLM5119-1F	
XL 1200 Classic	1996-2003	BLM5107-1F	BLM5106-2R
XL 1200 Custom	1996-2003	BLM5108-1F	BLM5106-2R

FRONT

REAR

BRAKE LINES



HARLEY-DAVIDSON®



		OE Replacement Brake Lines (Front)	OE Replacement Brake Lines (Rear)
XL 1200 R	2004-2011	BLM5109-3F	BLM5105-2R
XL 1200 Sport	1996-2003	BLM5110-3F	BLM5106-2R
XL 1200 Sportster	1988-2003	BLM5111-1F	BLM5106-2R
XL 1200C	2004-2013	BLM5112-1F	BLM5105-2R
XL 1200C/XL 1200CP	2012-2013	BLM5113-1F	BLM5105-2R
XL 1200 CP	2012	BLM5114-1F	BLM5105-2R
XL 1200 L Low	2007-2011	BLM5115-1F	BLM5105-2R
XL 1200 N Nightster	2008-2012	BLM5112-1F	BLM5105-2R
XL 1200 V Seventy Two	2012-2015	BLM5117-1F	
XL 1200 X Forty Eight	2012-2013	BLM5118-1F	BLM5105-2R
XL 1200 X Forty Eight	2014-2015	BLM5119-1F	
TOURING			
FLHR Road King	2008	BLM5008-4F	
FLHR	2014-2015	BLM5009-3F	
FLHR/FLHR-I Road King	1994-2007	BLM5010-3F	
FLHR/FLHRC	2008	BLM5011-1F	
FLHRC Road King Classic	1999-2007	BLM5010-3F	
FLHRS/FLHRSI Road King	2004-2007	BLM5013-3F	
FLHT/FLHTC/FLHTCU Electra Glide	1996-2007	BLM5014-3F	
FLHT/FLHTC/FLHTCU/FLHX	2008	BLM5015-4F	
FLHX Street Glide	2006-2007	BLM5014-3F	
FLHX	2014-2015	BLM5009-3F	
FLTR Road Glide ABS	2008-2013	BLM5042-4F	
FLTR/FLTR-I Road Glide	1998-2007	BLM5010-3F	
FLTRX/FLTRXS ABS	2015	BLM5044-1F	
FLTRX/FLTRXS	2015	BLM5045-3F	
V-ROD			
VRCSAW V-Rod	2008-2010	BLM5096-3F	
VRCSA/VRSCX V-Rod	2006-2008	BLM5097-3F	
VRCSA/VRSCX V-Rod	2004-2005	BLM5098-3F	
VRSCA V-Rod	2001-2005	BLM5099-3F	
VRSCA V-Rod	2006-2007	BLM5096-3F	
VRSCDX	2012	BLM5101-3F	
VRSCDX 10 Year Anniversary	2012-2013	BLM5097-3F	
VRSCDX Night Rod	2008-2011	BLM5097-3F	
VRSCF V-Rod Muscle	2009-2013	BLM5104-3F	

FRONT

REAR

EBC BRAKES CLUTCH KITS



SRC/SRK SERIES

The SRC series clutch kits include an aramid fibre lined facing for better heat and wear resistance. Plates should be smeared with drive case oil before install.

The SRK kits include a full set of friction plates lined with a carbon fiber based facing for even higher heat specs and also include new steel separator plates and a set of uprated springs hence a complete rebuild kit. Smear plates with drive case oil before install.



CK/CKF SERIES

These kits are a full engine set, measured to re-set the original "stack" height of the clutch. The plates are a moulded OEM style fiber bonded onto a steel backing. See your owners manual on oil type and install instructions to avoid clutch burn up or slippage.

The upgraded CKF range are again a full OEM size replacement friction plate only clutch pack but use a higher heat resistant carbon fiber impregnated facing. Smear plates with drive case oil before install.

Refer to EBC Brakes Clutch Kits listings for Motorcycle Model and Part No.
Box contents may vary.

Key Guide

CK – Full engine friction plate set similar to OEM (cork based material)

SRC – Full engine aramid fibre lined friction plate set with springs

SRK – Full engine aramid heavy duty friction plate set with steel driven plates and springs

EBC BRAKES CLUTCH KITS

CSK SERIES CLUTCH SPRING KITS

CSK sets include either coil springs or diaphragm springs where appropriate.



COIL SPRINGS

Coil springs are spiral wound with 4 to 10 pieces per set, made from heat treated high carbon steel delivering the right tension for your bike to avoid clutch slip. Springs always get tired after time and can promote clutch slip so when replacing the clutch - always replace the springs.



CSK Spring Kit #	Spring Length # mm	Spring Outer Diameter # mm	Spring Inner Diameter # mm	Quantity per pack
CSK230	47.21	20.04	14.87	4
CSK232	45.31	21.27	15.43	5
CSK233	43.44	20.81	15.51	4
CSK235	45.15	21.16	15.10	3
CSK236	46.70	21.20	15.30	3
CSK255	44.24	15.49	10.93	10
CSK257 -Big Coil	60.99/62.26	66.79/79.87	54.85/67.57	1

DIAPHRAGM SPRINGS

Diaphragm springs are dish shaped flat high carbon heat treated steel pressure rings made in the EBC UK pressworks.



CSK Diaphragm Spring Kit #	Spring Height # mm	Spring Outer Diameter # mm	Spring Inner Diameter # mm	Quantity per pack
CSK913	9.15	132.91	59.98	1
CSK914	9.25	145.78	61.01	1
CSK915	10.75	145.81	61.66	1
CSK916	10.40	145.88	61.38	1
CSK917	10.72	145.63	61.67	1
CSK918	6.97	132.88	59.75	1
CSK919	6.49	132.88	59.50	1
CSK920	6.85	132	60	1
CSK921	4.65	93	60.6	1

EBC BRAKES CLUTCH KITS

CK7002
CK7007

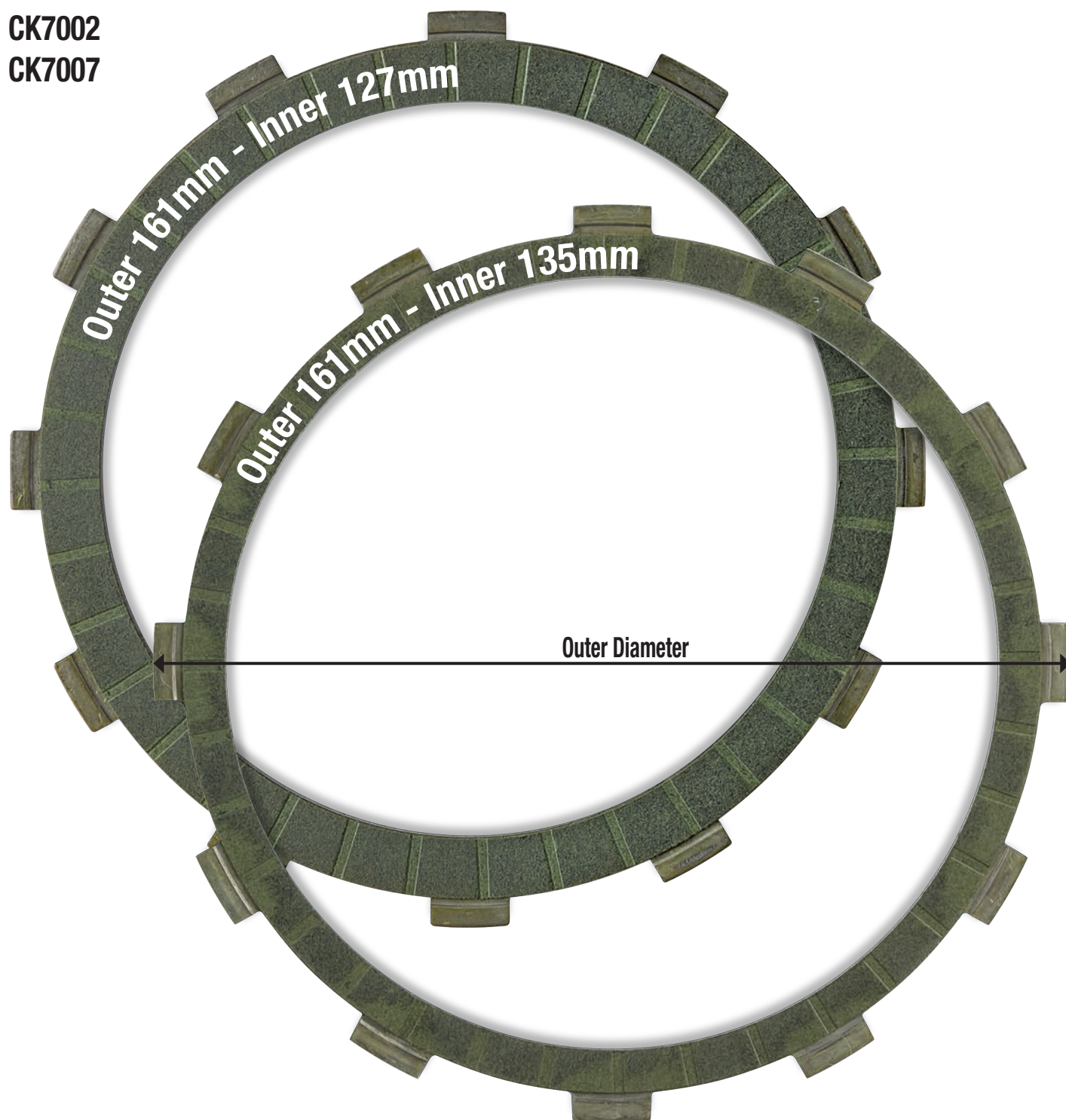

CK Series #	Dimensions and plate quantity. Outer Diameter - O/D Inner Diameter - I/D	CSK Spring Kit #	SRC Series Kit #	SRK Series Kit #	CT Clutch Tools #
CK7002	O/D=161mm-I/D=127mm x 6 plates. O/D=161mm-I/D=135mm x 3 plates	CSK235	SRC7003	SRK7003	CT702SP
CK7007	O/D=161mm-I/D=127mm x 7 plates. O/D=161mm-I/D=135mm x 3 plates	CSK236	SRC7008	SRK7008	CT708SP
CK7002	O/D=161mm-I/D=127mm x 6 plates. O/D=161mm-I/D=135mm x 3 plates	CSK236	SRC7010	SRK7010	CT702SP

EBC BRAKES CLUTCH KITS

CK7004

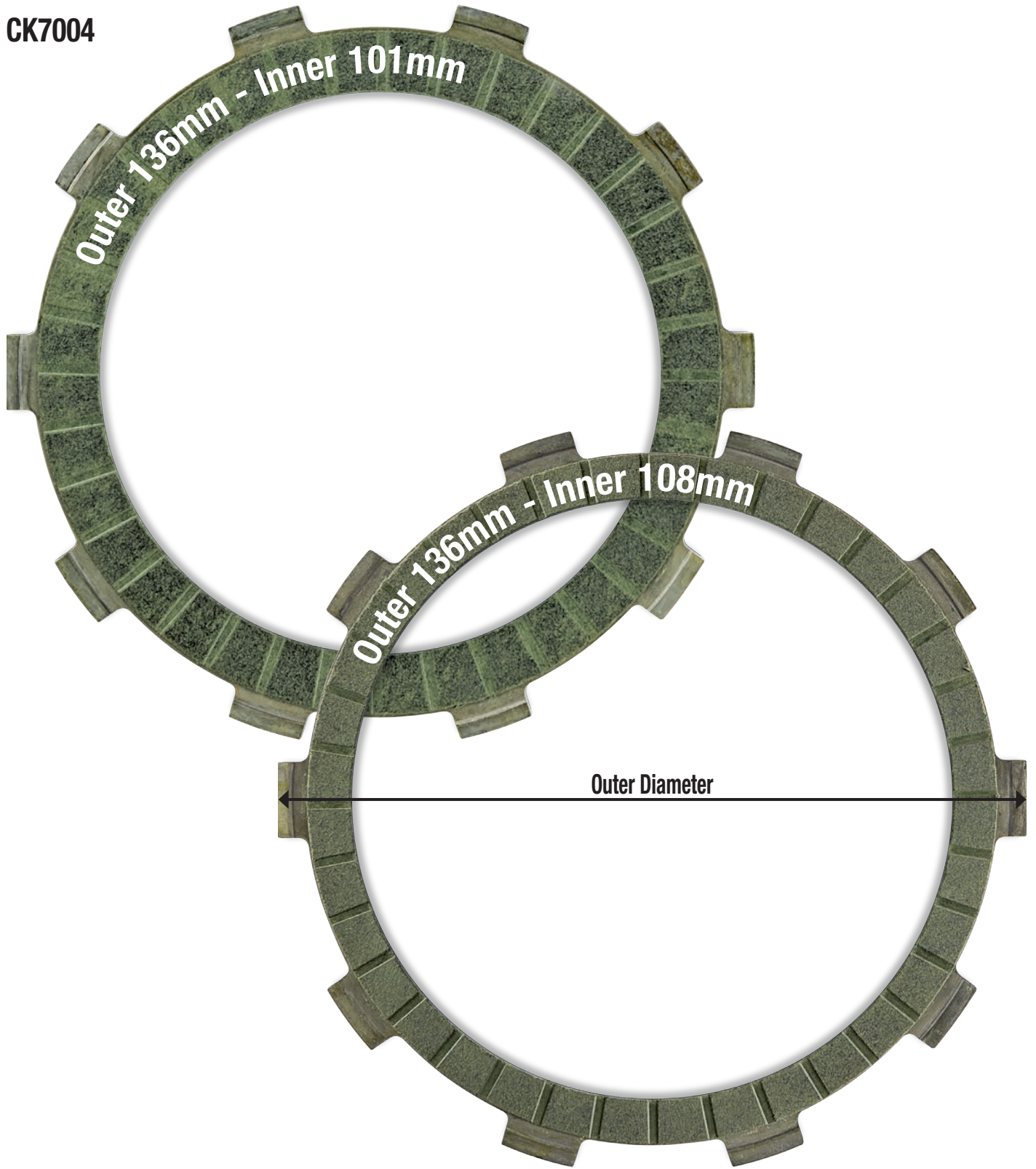

CK Series #	Dimensions and plate quantity. Outer Diameter - O/D Inner Diameter - I/D	CSK Spring Kit #	SRC Series Kit #	SRK Series Kit #	CT Clutch Tools #
CK7004	O/D=136mm-I/D=101mm x 7 plates. O/D=136mm-I/D=108mm x 1 plates.	CSK230	SRC7005	SRK7005	N/A

EBC BRAKES CLUTCH KITS

CK7009

CK7013

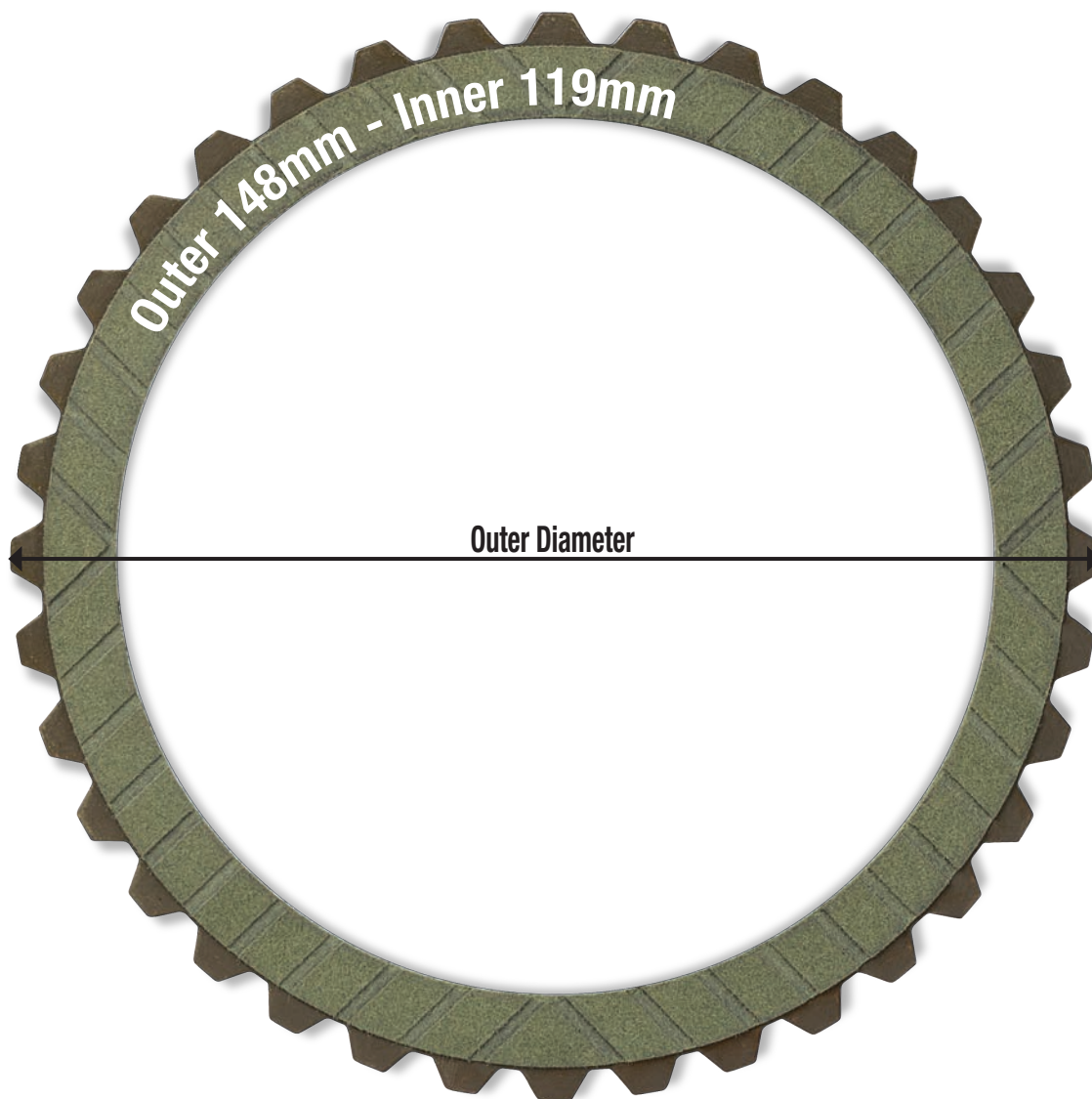

CK Series #	Dimensions and plate quantity. Outer Diameter - O/D Inner Diameter - I/D	CSK Spring Kit #	SRC Series Kit #	SRK Series Kit #	CT Clutch Tools #
CK7009	O/D=148mm-I/D=119mm x 8 plates.		SRC7014	SRK7014	CT701SP
CK7009	O/D=148mm-I/D=119mm x 8 plates.	CSK913	SRC7015	SRK7015	CT701SP
CK7009	O/D=148mm-I/D=119mm x 8 plates.		SRC7019	SRK7019	CT701SP
CK7009	O/D=148mm-I/D=119mm x 8 plates.	CSK919	SRC7020	SRK7020	CT701SP
CK7009	O/D=148mm-I/D=119mm x 8 plates.	CSK918	SRC7021	SRK7021	CT701SP
CK7009	O/D=148mm-I/D=119mm x 8 plates.	CSK920	SRC7023	SRK7023	CT701SP
CK7013	O/D=148mm-I/D=119mm x 8 plates.	CSK913	SRC7022	SRK7022	CT701SP

EBC BRAKES CLUTCH KITS

CK7010

CK7015

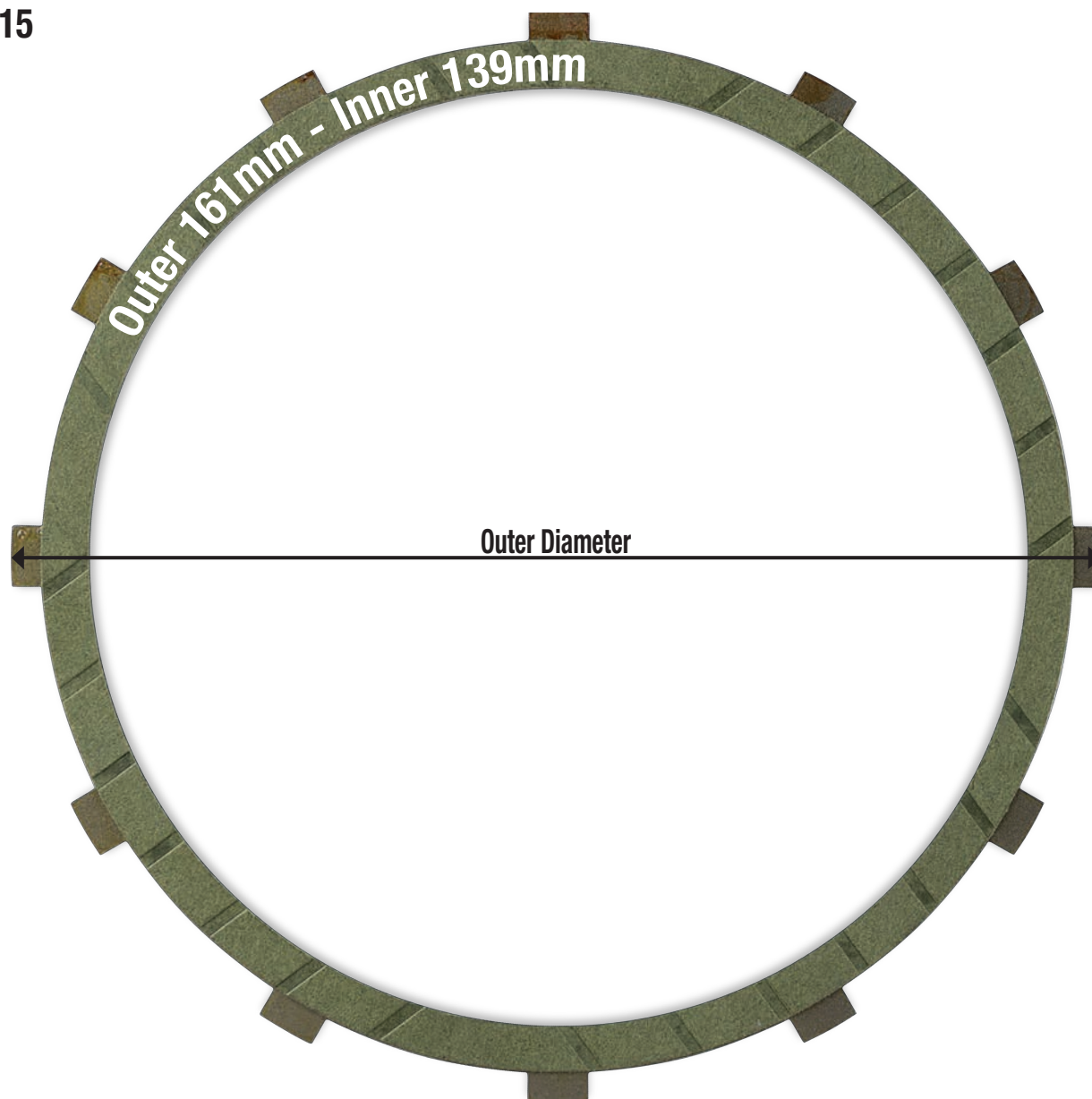

CK Series #	Dimensions and plate quantity. Outer Diameter - O/D Inner Diameter - I/D	CSK Spring Kit #	SRC Series Kit #	SRK Series Kit #	CT Clutch Tools #
CK7010	O/D=161mm-I/D=139mm x 6 plates.	CSK919	SRC7016	SRK7016	CT705SP
CK7015	O/D=161mm-I/D=139mm x 9 plates.	Big coil CSK257	SRC7025	SRK7025	CT701SP

EBC BRAKES CLUTCH KITS

CK7011
CK7012

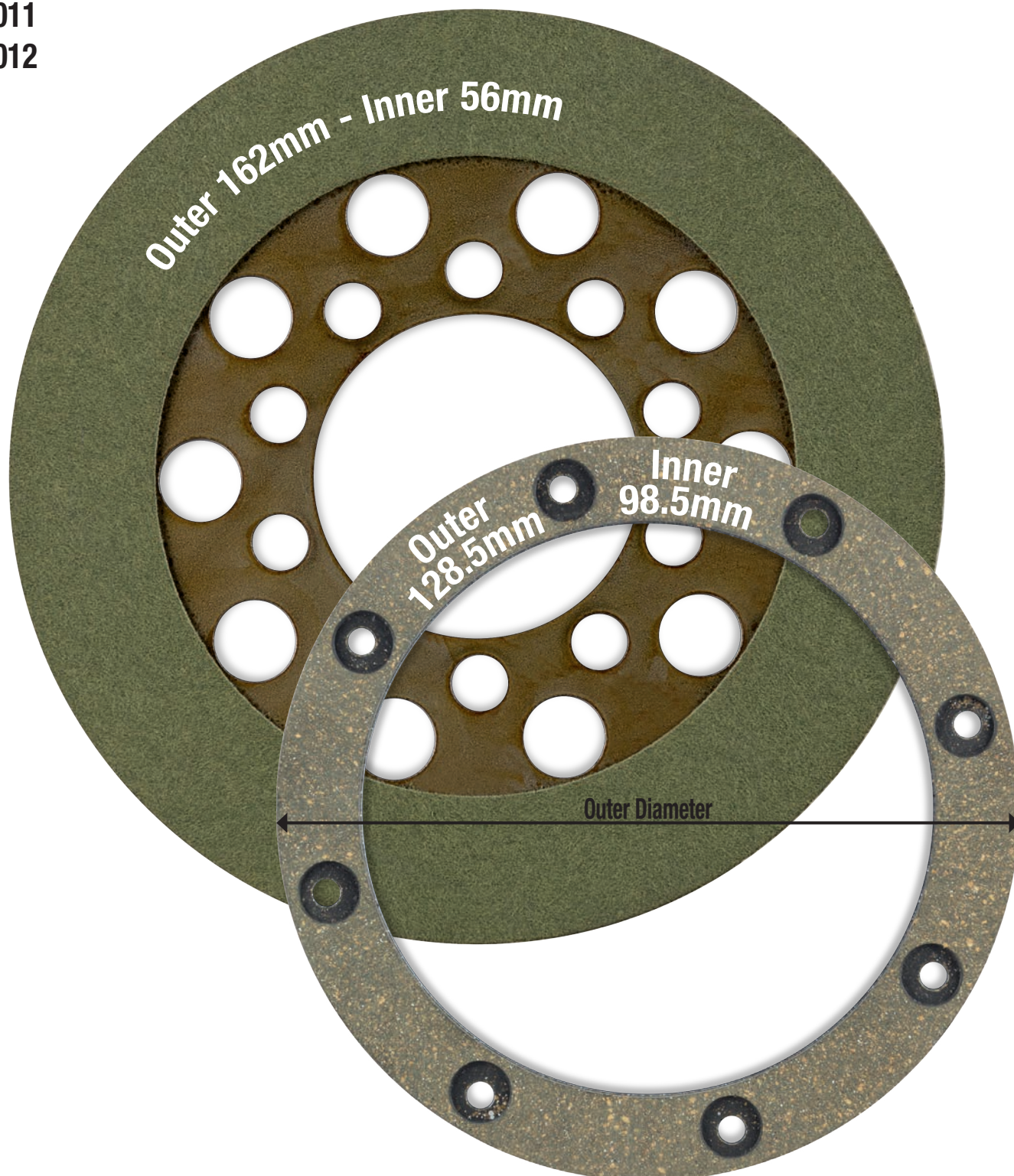

CK Series #	Dimensions and plate quantity. Outer Diameter - O/D Inner Diameter - I/D	CSK Spring Kit #	SRC Series Kit #	SRK Series Kit #	CT Clutch Tools #
CK7011	O/D=162mm-I/D=56mm x 5 plates.	CSK255	SRC7017	SRK7017	CT704SP
CK7012	O/D=162mm-I/D=56mm x 5 plates. O/D=128.5mm-I/D=98.5 x 1 plate.	CSK255	SRC7018	SRK7018	CT704SP

EBC BRAKES CLUTCH KITS

CK7005
CK7006

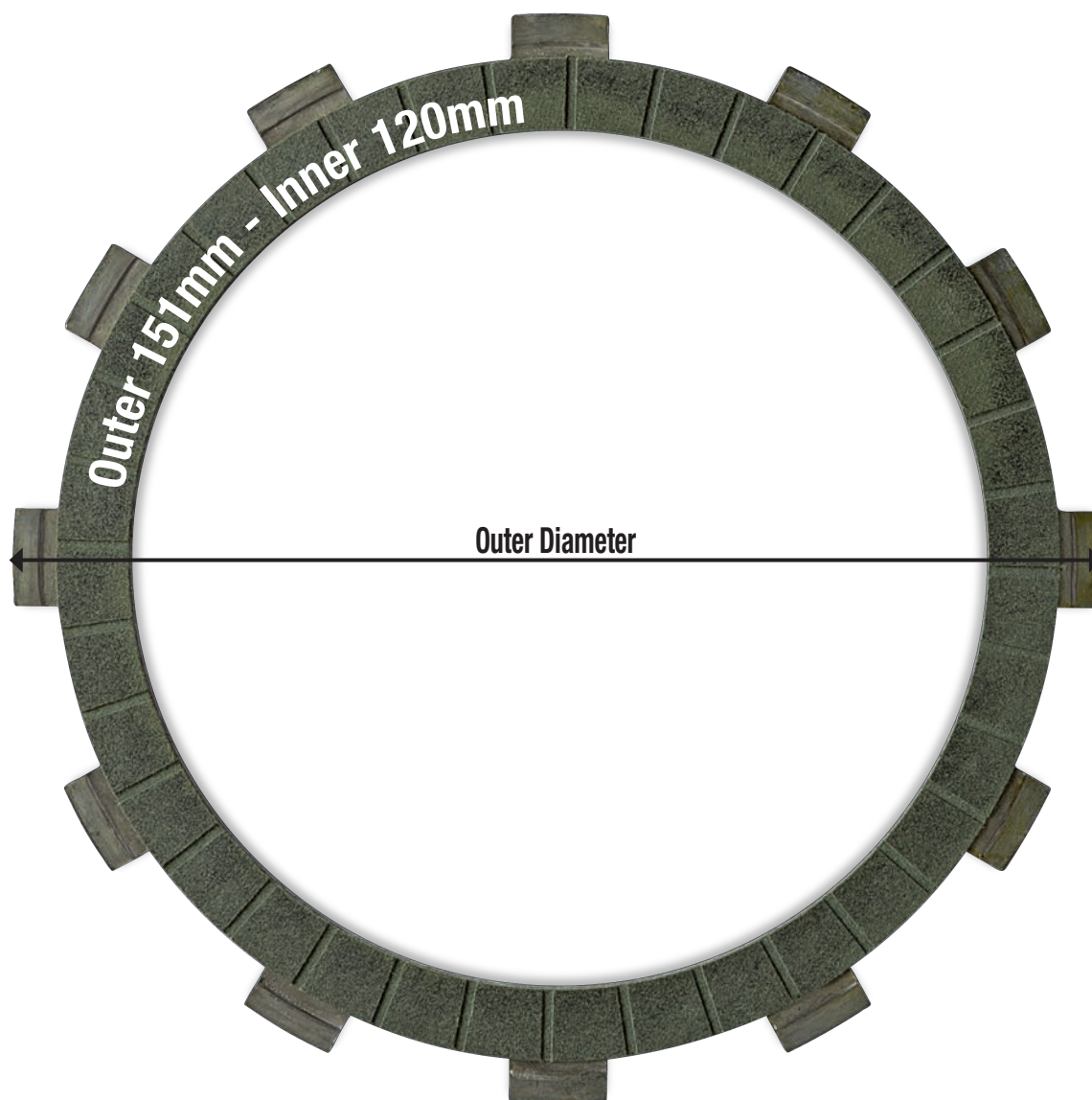

CK Series #	Dimensions and plate quantity. Outer Diameter - O/D Inner Diameter - I/D	CSK Spring Kit #	SRC Series Kit #	SRK Series Kit #	CT Clutch Tools #
CK7005	O/D=151mm-I/D=120mm x 9 plates.	CSK233	SRC7006	SRK7006	CT706SP
CK7006	O/D=151mm-I/D=120mm x 9 plates.	CSK232	SRC7007	SRK7007	CT706SP

EBC BRAKES CLUTCH KITS

CK7008
CK7014

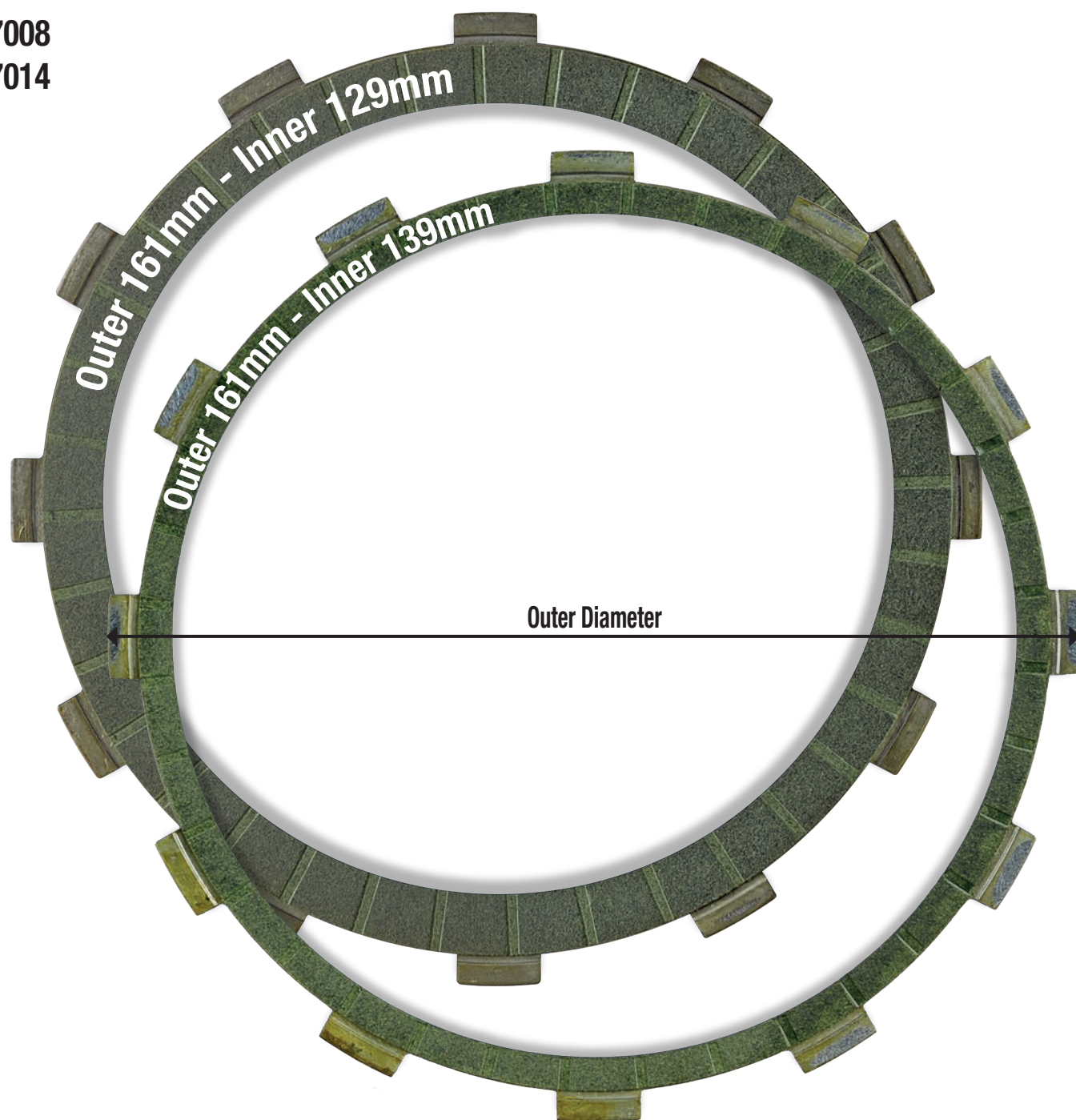

CK Series #	Dimensions and plate quantity. Outer Diameter - O/D Inner Diameter - I/D	CSK Spring Kit #	SRC Series Kit #	SRK Series Kit #	CT Clutch Tools #
CK7008	O/D=161mm-I/D=129mm x 8 plates. O/D=161mm-I/D=139 x 1 plate.	CSK914	SRC7009	SRK7009	CT703SP
CK7008	O/D=161mm-I/D=129mm x 8 plates. O/D=161mm-I/D=139 x 1 plate.	CSK917	SRC7011	SRK7011	CT703SP
CK7008	O/D=161mm-I/D=129mm x 8 plates. O/D=161mm-I/D=139 x 1 plate.	CSK916	SRC7012	SRK7012	CT703SP
CK7008	O/D=161mm-I/D=129mm x 8 plates. O/D=161mm-I/D=139 x 1 plate.	CSK915	SRC7013	SRK7013	CT703SP
CK7014	O/D=161mm-I/D=129mm x 7 plates.	CSK921	SRC7024	SRK7024	CT701SP

CT CLUTCH REMOVAL TOOLS

Made in the UK, these laser cut clutch removal tools make clutch removal, loosening of the drive shaft bolts and re-tightening a breeze, without any fear of damage to your expensive clutch basket.

Tools can be extended to create more leverage if required with any simple workshop tool or tube. EBC Brakes produce a clutch tool for almost every clutch plate design known.



CAUTION: replacing a clutch kit requires skill, expertise and a good workshop, plus tools. A small press and a spring compressor may be needed. If you are not familiar with these routines, use a competent dealer or visit www.fixmyhog.com as an example of how to guide you safely.

EBC BRAKES CLUTCH KITS



HARLEY-DAVIDSON®



		CK Series Moulded OEM style facings #	CSK Spring Kit #	SRC Series Kit #	SRK Series Kit #	CT Tool #
SPORTSTER						
XLH 1000	1984	CK7014	CSK921	SRC7024	SRK7024	CT709SP
XLH 1000	1981-1984	CK7015	CSK257-Big Coil	SRC7025	SRK7025	CT709SP
XLH 1000 Standard	1971-1978	CK7015	CSK256	SRC7025	SRK7025	CT709SP
XLH 1000 Standard	1971-1978	CK7015	CSK257-Big Coil	SRC7025	SRK7025	CT709SP
XLHC 1000	1979-1980	CK7015	CSK257-Big Coil	SRC7025	SRK7025	CT709SP
XLS1000 Roadster	1984	CK7014	CSK921	SRC7024	SRK7024	CT709SP
XLS1000 Roadster	1981-1984	CK7015	CSK257-Big Coil	SRC7025	SRK7025	CT709SP
XR1000	1983	CK7015	CSK257-Big Coil	SRC7025	SRK7025	CT709SP
XR1000	1984	CK7014	CSK921	SRC7024	SRK7024	CT709SP
XR1000	1984	CK7015	CSK257-Big Coil	SRC7025	SRK7025	CT709SP
XLH1100	1986-1990	CK7014	CSK921	SRC7024	SRK7024	CT709SP
XL883	1986-1990	CK7014	CSK921	SRC7024	SRK7024	CT709SP
XL883	1991-2003	CK7009	CSK920	SRC7023	SRK7023	CT701SP
XL883	2004-2009	CK7009	CSK918	SRC7021	SRK7021	CT701SP
XL883C Custom	1998-2003	CK7009	CSK920	SRC7023	SRK7023	CT701SP
XL883C Custom	2004-2010	CK7009	CSK918	SRC7021	SRK7021	CT701SP
XL883DLX Deluxe	1986-1990	CK7014	CSK921	SRC7024	SRK7024	CT709SP
XL883DLX Deluxe	1991-1995	CK7009	CSK920	SRC7023	SRK7023	CT701SP
XL883HUG Hugger	1987-1990	CK7014	CSK921	SRC7024	SRK7024	CT709SP
XL883HUG Hugger	1991-2003	CK7009	CSK920	SRC7023	SRK7023	CT701SP
XL883L Low	2005-2011	CK7009	CSK918	SRC7021	SRK7021	CT701SP
XL883L SuperLow	2012-2020	CK7009	CSK918	SRC7021	SRK7021	CT701SP
XL883N Iron	2009-2022	CK7009	CSK918	SRC7021	SRK7021	CT701SP
XL883R	2002-2006	CK7009	CSK920	SRC7023	SRK7023	CT701SP
XL883R	2007-2010	CK7009	CSK918	SRC7021	SRK7021	CT701SP
XL883R Roadster	2011-2015	CK7009	CSK918	SRC7021	SRK7021	CT701SP
XL 1200 C 1CT3 Custom	2007-2020	CK7009	CSK919	SRC7020	SRK7020	CT701SP
XL 1200 CB 1LK3 Custom Limited B	2013-2017	CK7009	CSK919	SRC7020	SRK7020	CT701SP
XL 1200 CP Custom H-D1	2011-2016	CK7009	CSK919	SRC7020	SRK7020	CT701SP
XL 1200 CX 3LM3 Roadster	2016-2020	CK7009	CSK919	SRC7020	SRK7020	CT701SP
XL 1200 50th Anniversary Sportster	2007	CK7009	CSK919	SRC7020	SRK7020	CT701SP
XL1200	1991-2003	CK7009	CSK920	SRC7023	SRK7023	CT701SP
XL1200C Custom	2004-2006	CK7009	CSK919	SRC7020	SRK7020	CT701SP
XL1200C Custom	1996-2003	CK7009	CSK920	SRC7023	SRK7023	CT701SP
XL1200CA Custom Limited A	2013-2016	CK7009	CSK919	SRC7020	SRK7020	CT701SP
XL1200 C ANV Custom Anniversary	2013	CK7009	CSK919	SRC7020	SRK7020	CT701SP
XL1200L Low	2006-2011	CK7009	CSK919	SRC7020	SRK7020	CT701SP
XL1200N Nightster	2007-2012	CK7009	CSK919	SRC7020	SRK7020	CT701SP
XL1200NS Iron	2018-2021	CK7009	CSK919	SRC7020	SRK7020	CT701SP
XL1200R Roadster	2004-2009	CK7009	CSK919	SRC7020	SRK7020	CT701SP
XL1200S Sport	1996-2003	CK7009	CSK920	SRC7023	SRK7023	CT701SP
XL1200T SuperLow	2014-2020	CK7009	CSK919	SRC7020	SRK7020	CT701SP
XL1200V Seventy-Two	2012-2016	CK7009	CSK919	SRC7020	SRK7020	CT701SP
XL1200X Forty Eight	2010-2022	CK7009	CSK919	SRC7020	SRK7020	CT701SP
XL1200XS Forty Eight Special	2018-2020	CK7009	CSK919	SRC7020	SRK7020	CT701SP
XL1200XS ANV Forty Eight Anniversary	2018	CK7009	CSK919	SRC7020	SRK7020	CT701SP
XL50 50th Anniversary	2007	CK7009	CSK919	SRC7020	SRK7020	CT701SP
XR1200	2008-2010	CK7013	CSK913	SRC7022	SRK7022	CT701SP
XR1200X	2010-2013	CK7013	CSK913	SRC7022	SRK7022	CT701SP
STREET						
XG500	2015-2021	CK7004	CSK230	SRC7005	SRK7005	
XG750	2015-2021	CK7004	CSK229	SRC7005	SRK7005	

EBC BRAKES CLUTCH KITS



HARLEY-DAVIDSON®



		CK Series Moulded OEM style facings #	CSK Spring Kit #	SRC Series Kit #	SRK Series Kit #	CT Tool #
DYNA						
FXB BDKB Super Glide B80	1981-1982	CK7012	CSK255	SRC7018	SRK7018	CT704SP
FXD Super Glide	1995-1997	CK7009		SRC7019	SRK7019	CT701SP
FXD Super Glide	1998-2003	CK7008	CSK917	SRC7011	SRK7011	CT703SP
FXDB Daytona	1992	CK7009		SRC7019	SRK7019	CT701SP
FXDB Sturgis	1991	CK7009		SRC7019	SRK7019	CT701SP
FXDC Super Glide Custom	1992	CK7009		SRC7019	SRK7019	CT701SP
FXDG Glide Glide Custom	1983	CK7012	CSK255	SRC7018	SRK7018	CT704SP
FXDL Low Rider	1993-1997	CK7009		SRC7019	SRK7019	CT701SP
FXDL Low Rider	1998-2003	CK7008	CSK917	SRC7011	SRK7011	CT703SP
FXDSCONV Glide Convertible	1993	CK7009		SRC7019	SRK7019	CT701SP
FXDWG Wide Glide	1993-1997	CK7009		SRC7019	SRK7019	CT701SP
FXE Super Glide	1984	CK7010	CSK919	SRC7016	SRK7016	CT705SP
FXE Super Glide	1981-1984	CK7012	CSK255	SRC7018	SRK7018	CT704SP
FXEF Super Glide Fat Bob	1981	CK7012	CSK255	SRC7018	SRK7018	CT704SP
FXEF Super Glide Fat Bob	1985	CK7010	CSK919	SRC7016	SRK7016	CT705SP
FXWG Wide Glide	1981-1984	CK7012	CSK255	SRC7018	SRK7018	CT704SP
FXWG Wide Glide	1984-1986	CK7010	CSK919	SRC7016	SRK7016	CT705SP
FXD Super Glide	2004-2005	CK7008	CSK916	SRC7012	SRK7012	CT703SP
FXDBI Street Bob	2006	CK7008	CSK915	SRC7013	SRK7013	CT703SP
FXDC Super Glide Custom	2005	CK7008	CSK916	SRC7012	SRK7012	CT703SP
FXDCI Super Glide Custom	2005-2006	CK7008	CSK915	SRC7013	SRK7013	CT703SP
FXDI Super Glide	2004-2006	CK7008	CSK915	SRC7013	SRK7013	CT703SP
FXDL Low Rider	2006-2017	CK7008	CSK915	SRC7013	SRK7013	CT703SP
FXDL/I Low Rider	2004-2005	CK7008	CSK916	SRC7012	SRK7012	CT703SP
FXDSCONV Glide Convertible	1999-2000	CK7008	CSK917	SRC7011	SRK7011	CT703SP
FXDWG Wide Glide	1998-2005	CK7008	CSK917	SRC7011	SRK7011	CT703SP
FXDWGI Wide Glide	2004-2006	CK7008	CSK916	SRC7012	SRK7012	CT703SP
FXDX Super Glide Sport	1999-2003	CK7008	CSK917	SRC7011	SRK7011	CT703SP
FXDX Super Glide Sport	2004-2005	CK7008	CSK916	SRC7012	SRK7012	CT703SP
FXDXT Super Glide T-Sport	2001-2003	CK7008	CSK917	SRC7011	SRK7011	CT703SP
FXD Super Glide	2007-2010	CK7008	CSK915	SRC7013	SRK7013	CT703SP
FXD35 35th Anniversary Super Glide	2006	CK7008	CSK915	SRC7013	SRK7013	CT703SP
FXDB Street Bob	2007-2017	CK7008	CSK915	SRC7013	SRK7013	CT703SP
FXDBA Street Bob HD-1	2013-2015	CK7008	CSK915	SRC7013	SRK7013	CT703SP
FXDC Super Glide Custom	2007-2014	CK7008	CSK915	SRC7013	SRK7013	CT703SP
FXDCANV Super Glide Custom Anniversary	2013	CK7008	CSK915	SRC7013	SRK7013	CT703SP
FXDF Fat Bob	2008-2017	CK7008	CSK915	SRC7013	SRK7013	CT703SP
FXDWG Wide Glide	2007-2016	CK7008	CSK915	SRC7013	SRK7013	CT703SP
FXDWGANV Wide Glide 105th Anniversary	2008	CK7008	CSK915	SRC7013	SRK7013	CT703SP
FXS Blackline	2011-2013	CK7008	CSK916	SRC7012	SRK7012	CT703SP
FLD 103 Switchback	2012-2016	CK7008	CSK916	SRC7012	SRK7012	CT703SP
FLD Dyna Switchback	2012-2017	CK7008	CSK915	SRC7013	SRK7013	CT703SP
FXDB 103 Street Bob	2014-2017	CK7008	CSK916	SRC7012	SRK7012	CT703SP
FXDBA 103 Street Bob	2013-2015	CK7008	CSK916	SRC7012	SRK7012	CT703SP
FXDBC 103 Street Bob Limited	2016	CK7008	CSK916	SRC7012	SRK7012	CT703SP
FXDBC Street Bob Limited	2016	CK7008	CSK915	SRC7013	SRK7013	CT703SP
FXDBP 103 Street Bob	2016	CK7008	CSK916	SRC7012	SRK7012	CT703SP
FXDC 103 Super Glide Custom	2014	CK7008	CSK916	SRC7012	SRK7012	CT703SP
FXDF 103 Fat Bob	2012-2017	CK7008	CSK916	SRC7012	SRK7012	CT703SP
FXDL 103 Low Rider	2014-2017	CK7008	CSK916	SRC7012	SRK7012	CT703SP
FXDLS Low Rider S	2016-2017	CK7008	CSK914	SRC7009	SRK7009	CT703SP
FXDWG 103 Wide Glide	2013-2017	CK7008	CSK916	SRC7012	SRK7012	CT703SP
FXS 103 Blackline	2012-2013	CK7008	CSK916	SRC7012	SRK7012	CT703SP
FXSB 103 Softail Breakout	2013-2015	CK7008	CSK916	SRC7012	SRK7012	CT703SP

EBC BRAKES CLUTCH KITS



HARLEY-DAVIDSON®



		CK Series Moulded OEM style facings #	CSK Spring Kit #	SRC Series Kit #	SRK Series Kit #	CT Tool #
SOFTAIL						
FLHC Electra Glide Classic	1981-1982	CK7012	CSK255	SRC7018	SRK7018	CT704SP
FLST Heritage	1986-1990	CK7010	CSK919	SRC7016	SRK7016	CT705SP
FLSTC Heritage Classic	1987-1989	CK7010	CSK919	SRC7016	SRK7016	CT705SP
FLSTC Heritage Classic	1990-1997	CK7009		SRC7019	SRK7019	CT701SP
FLSTC Heritage Classic	1998-2003	CK7008	CSK917	SRC7011	SRK7011	CT703SP
FLSTF Fat Boy	1990-1997	CK7009		SRC7019	SRK7019	CT701SP
FLSTF Fat Boy	1998-2003	CK7008	CSK917	SRC7011	SRK7011	CT703SP
FLSTN Heritage Nostalgia	1993-1996	CK7009		SRC7019	SRK7019	CT701SP
FLSTS Heritage Springer	1997	CK7009		SRC7019	SRK7019	CT701SP
FLSTS Heritage Springer	1998-2003	CK7008	CSK917	SRC7011	SRK7011	CT703SP
FXS Super Glide	1981-1982	CK7012	CSK255	SRC7018	SRK7018	CT704SP
FXSB Low Rider	1985	CK7010	CSK919	SRC7016	SRK7016	CT705SP
FXSB Low Rider	1983-1984	CK7012	CSK255	SRC7018	SRK7018	CT704SP
FXST Standard	1984-1989	CK7010	CSK919	SRC7016	SRK7016	CT705SP
FXST Standard	1984	CK7012	CSK255	SRC7018	SRK7018	CT704SP
FXSTC Custom	1986-1989	CK7010	CSK919	SRC7016	SRK7016	CT705SP
FXSTC Custom	1990-1997	CK7009		SRC7019	SRK7019	CT701SP
FXSTC Custom	1998-1999	CK7008	CSK917	SRC7011	SRK7011	CT703SP
FXSTD Deuce	2000-2003	CK7008	CSK917	SRC7011	SRK7011	CT703SP
FXSTS Springer	1988-1989	CK7010	CSK919	SRC7016	SRK7016	CT705SP
FXSTS Springer	1990-1998	CK7009		SRC7019	SRK7019	CT701SP
FLST Heritage	2006-2009	CK7008	CSK915	SRC7013	SRK7013	CT703SP
FLSTC Heritage Classic	2006-2015	CK7008	CSK915	SRC7013	SRK7013	CT703SP
FLSTC Heritage Classic	2004-2005	CK7008	CSK916	SRC7012	SRK7012	CT703SP
FLSTCI Heritage Classic	2006	CK7008	CSK915	SRC7013	SRK7013	CT703SP
FLSTCI Heritage Classic	2001-2003	CK7008	CSK917	SRC7011	SRK7011	CT703SP
FLSTCI Heritage Classic Shrine	2005	CK7008	CSK916	SRC7012	SRK7012	CT703SP
FLSTCI Heritage Softail Classic	2004-2005	CK7008	CSK916	SRC7012	SRK7012	CT703SP
FLSTF Fat Boy	2004-2005	CK7008	CSK916	SRC7012	SRK7012	CT703SP
FLSTF Fat Boy	2006-2011	CK7008	CSK915	SRC7013	SRK7013	CT703SP
FLSTFB Fat Boy LO	2010-2011	CK7008	CSK915	SRC7013	SRK7013	CT703SP
FLSTFI Fat Boy	2006	CK7008	CSK915	SRC7013	SRK7013	CT703SP
FLSTFI Fat Boy	2001-2003	CK7008	CSK917	SRC7011	SRK7011	CT703SP
FLSTFI Fat Boy	2004-2005	CK7008	CSK916	SRC7012	SRK7012	CT703SP
FLSTFI Fat Boy Shrine	2005-2006	CK7008	CSK916	SRC7012	SRK7012	CT703SP
FLSTN Deluxe	2005-2015	CK7008	CSK916	SRC7012	SRK7012	CT703SP
FLSTNI Deluxe	2006	CK7008	CSK915	SRC7013	SRK7013	CT703SP
FLSTSB Cross Bones	2008-2011	CK7008	CSK915	SRC7013	SRK7013	CT703SP
FLSTSC Springer Classic	2006-2007	CK7008	CSK915	SRC7013	SRK7013	CT703SP
FLSTSC Springer Classic	2005	CK7008	CSK916	SRC7012	SRK7012	CT703SP
FLSTSI Heritage Springer	2001-2003	CK7008	CSK917	SRC7011	SRK7011	CT703SP
FXST Standard	1999-2003	CK7008	CSK917	SRC7011	SRK7011	CT703SP
FXST Standard	2004-2006	CK7008	CSK916	SRC7012	SRK7012	CT703SP
FXSTB Night Train	1999-2003	CK7008	CSK917	SRC7011	SRK7011	CT703SP
FXSTB Night Train	2004-2005	CK7008	CSK916	SRC7012	SRK7012	CT703SP
FXSTB Night Train	2006-2009	CK7008	CSK915	SRC7013	SRK7013	CT703SP
FXSTBI Night Train	2006	CK7008	CSK915	SRC7013	SRK7013	CT703SP
FXSTBI Night Train	2001-2003	CK7008	CSK917	SRC7011	SRK7011	CT703SP
FXSTBI Night Train	2004-2005	CK7008	CSK916	SRC7012	SRK7012	CT703SP
FXSTD Deuce	2004-2005	CK7008	CSK916	SRC7012	SRK7012	CT703SP
FXSTD Deuce	2006-2007	CK7008	CSK915	SRC7013	SRK7013	CT703SP
FXSTI Standard	2006	CK7008	CSK915	SRC7013	SRK7013	CT703SP
FXSTI Standard	2001-2003	CK7008	CSK917	SRC7011	SRK7011	CT703SP
FXSTI Standard	2004-2005	CK7008	CSK916	SRC7012	SRK7012	CT703SP
FXSTS Springer	2006	CK7008	CSK915	SRC7013	SRK7013	CT703SP
FXSTS Springer	1999-2003	CK7008	CSK917	SRC7011	SRK7011	CT703SP

EBC BRAKES CLUTCH KITS



HARLEY-DAVIDSON®



		CK Series Moulded OEM style facings #	CSK Spring Kit #	SRC Series Kit #	SRK Series Kit #	CT Tool #
FXSTS Springer	2004-2005	CK7008	CSK916	SRC7012	SRK7012	CT703SP
FXSTSI Springer	2006	CK7008	CSK915	SRC7013	SRK7013	CT703SP
FXSTSI Springer	2001-2003	CK7008	CSK917	SRC7011	SRK7011	CT703SP
FXSTSI Springer	2004-2005	CK7008	CSK916	SRC7012	SRK7012	CT703SP
FXCWC Rocker C	2008-2011	CK7008	CSK915	SRC7013	SRK7013	CT703SP
FXS Blackline	2011	CK7008	CSK915	SRC7013	SRK7013	CT703SP
FXST Standard	1990	CK7009		SRC7019	SRK7019	CT701SP
FXST Standard	2007-2011	CK7008	CSK915	SRC7013	SRK7013	CT703SP
FXSTC Custom	2007-2010	CK7008	CSK915	SRC7013	SRK7013	CT703SP
FXCW Rocker	2008-2009	CK7008	CSK915	SRC7013	SRK7013	CT703SP
FLS 103 Slim	2013-2015	CK7008	CSK916	SRC7012	SRK7012	CT703SP
FLS Slim	2012-2015	CK7008	CSK915	SRC7013	SRK7013	CT703SP
FLS Slim	2016-2017	CK7008	CSK916	SRC7012	SRK7012	CT703SP
FLSS Slim S	2016-2017	CK7002	CSK235	SRC7003	SRK7003	CT702SP
FLSTC 103 Heritage Classic	2012-2015	CK7008	CSK916	SRC7012	SRK7012	CT703SP
FLSTC Heritage Softail Classic	2016-2017	CK7008	CSK916	SRC7012	SRK7012	CT703SP
FLSTC103ANV Heritage Classic Anniversary	2013	CK7008	CSK916	SRC7012	SRK7012	CT703SP
FLSTCANV Heritage Classic Anniversary	2013	CK7008	CSK915	SRC7013	SRK7013	CT703SP
FLSTF Fat Boy	2012-2017	CK7008	CSK916	SRC7012	SRK7012	CT703SP
FLSTFB Fat Boy LO	2012-2017	CK7008	CSK916	SRC7012	SRK7012	CT703SP
FLSTFBANV Fat Boy LO Anniversary	2013	CK7008	CSK916	SRC7012	SRK7012	CT703SP
FLSTFBS Fat Boy S	2016-2017	CK7002	CSK916	SRC7012	SRK7012	CT702SP
FLSTN 103 Deluxe	2012-2015	CK7008	CSK916	SRC7012	SRK7012	CT703SP
FLSTN Deluxe	2016-2017	CK7008	CSK916	SRC7012	SRK7012	CT703SP
FXS Blackline	2012	CK7008	CSK916	SRC7012	SRK7012	CT703SP
FXS Blackline	2013	CK7008	CSK915	SRC7013	SRK7013	CT703SP
FXSB 103 Breakout	2013-2015	CK7008	CSK916	SRC7012	SRK7012	CT703SP
FXSB Breakout	2013-2017	CK7008	CSK915	SRC7013	SRK7013	CT703SP
FXST Standard	2012-2015	CK7008	CSK916	SRC7012	SRK7012	CT703SP
FXBBS Street Bob	2018-2020	CK7007	CSK236	SRC7008	SRK7008	CT708SP
FXBR Breakout	2018-2024	CK7007	CSK236	SRC7008	SRK7008	CT708SP
FXBRS Breakout 114	2018-2020	CK7007	CSK236	SRC7008	SRK7008	CT708SP
FXBRS Breakout 114 Anniversary	2018	CK7007	CSK236	SRC7008	SRK7008	CT708SP
FXFB Fat Bob	2018-2020	CK7007	CSK236	SRC7008	SRK7008	CT708SP
FXLR Low Rider	2018-2020	CK7007	CSK236	SRC7008	SRK7008	CT708SP
FXLRS Low Rider S	2020-2024	CK7007	CSK236	SRC7008	SRK7008	CT708SP
FXLRS Low Rider ST	2022-2024	CK7007	CSK236	SRC7008	SRK7008	CT708SP
FLHC Heritage Classic	2018-2021	CK7007	CSK236	SRC7008	SRK7008	CT708SP
FLSB Sport Glide	2018-2024	CK7007	CSK236	SRC7008	SRK7008	CT708SP
FLSL Slim	2018-2021	CK7007	CSK236	SRC7008	SRK7008	CT708SP
FXST Standard	2020-2024	CK7007	CSK236	SRC7008	SRK7008	CT708SP
FLDE Deluxe	2018-2020	CK7007	CSK236	SRC7008	SRK7008	CT708SP
FLFB Fat Boy	2018-2020	CK7007	CSK236	SRC7008	SRK7008	CT708SP
FLFBS Fat Boy 114	2018-2024	CK7007	CSK236	SRC7008	SRK7008	CT708SP
FLFBS Fat Boy 114 Anniversary	2018	CK7007	CSK236	SRC7008	SRK7008	CT708SP
FLFBS Fat Boy 114 Anniversary	2020	CK7007	CSK236	SRC7008	SRK7008	CT708SP
FLFBS Fat Boy 114 Anniversary	2023	CK7007	CSK236	SRC7008	SRK7008	CT708SP
FLHCS Heritage Classic 114	2018-2024	CK7007	CSK236	SRC7008	SRK7008	CT708SP
FLHCS Heritage Classic 114 Anniversary	2018	CK7007	CSK236	SRC7008	SRK7008	CT708SP
FLHCS Heritage Classic 114 Anniversary	2023	CK7007	CSK236	SRC7008	SRK7008	CT708SP
FLI Hydra-Glide Revival	2024-2025	CK7007	CSK236	SRC7008	SRK7008	CT708SP
FXBBS Street Bob 114	2021-2024	CK7007	CSK236	SRC7008	SRK7008	CT708SP
FXDR 114	2019-2020	CK7007	CSK236	SRC7008	SRK7008	CT708SP
FXFBS Fat Bob 114	2018-2024	CK7007	CSK236	SRC7008	SRK7008	CT708SP
FXRST Low Rider EL DIABLO	2022	CK7007	CSK236	SRC7008	SRK7008	CT708SP

EBC BRAKES CLUTCH KITS



HARLEY-DAVIDSON®



		CK Series Moulded OEM style facings #	CSK Spring Kit #	SRC Series Kit #	SRK Series Kit #	CT Tool #
TOURING						
FLH Electra Glide	1984	CK7011	CSK255	SRC7017	SRK7017	CT704SP
FLH Electra Glide	1981-1983	CK7012	CSK255	SRC7018	SRK7018	CT704SP
FLH Electra Glide Shrine Shovelhead	1983	CK7012	CSK255	SRC7018	SRK7018	CT704SP
FLH Electra Glide Shrine Shovelhead	1984	CK7011	CSK255	SRC7017	SRK7017	CT704SP
FLHR Road King	1993-1997	CK7009		SRC7014	SRK7014	CT701SP
FLHR Road King	1998-2003	CK7008	CSK917	SRC7011	SRK7011	CT703SP
FLHS Electra Glide Heritage	1981	CK7012	CSK255	SRC7018	SRK7018	CT704SP
FLHS Electra Glide Sport	1984	CK7011	CSK255	SRC7017	SRK7017	CT704SP
FLHS Electra Glide Sport	1981-1983	CK7012	CSK255	SRC7018	SRK7018	CT704SP
FLHS Electra Glide Sport	1984-1989	CK7010	CSK919	SRC7016	SRK7016	CT705SP
FLHS Electra Glide Sport	1991-1994	CK7009		SRC7014	SRK7014	CT701SP
FLHS Touring Electra Glide Sport	1990	CK7009	CSK913	SRC7015	SRK7015	CT701SP
FLHT Electra Glide	1984	CK7011	CSK255	SRC7017	SRK7017	CT704SP
FLHT Electra Glide	1984	CK7010	CSK919	SRC7016	SRK7016	CT705SP
FLHT Electra Glide - Early 1984	1984	CK7011	CSK255	SRC7017	SRK7017	CT704SP
FLHT Electra Glide - Later 1984	1984	CK7010	CSK919	SRC7016	SRK7016	CT705SP
FLHT Electra Glide Classic	1983	CK7012	CSK255	SRC7018	SRK7018	CT704SP
FLHT Electra Glide Classic	1984	CK7011	CSK255	SRC7017	SRK7017	CT704SP
FLHT Electra Glide Classic	1984	CK7010	CSK919	SRC7016	SRK7016	CT704SP
FLHT Electra Glide Classic - Early 1984	1984	CK7011	CSK255	SRC7017	SRK7017	CT704SP
FLHT Electra Glide Classic - Later 1984	1984	CK7010	CSK919	SRC7016	SRK7016	CT705SP
FLHT Electra Glide Shrine Shovelhead	1984	CK7010	CSK919	SRC7016	SRK7016	CT705SP
FLHT Electra Glide Standard	1983	CK7012	CSK255	SRC7018	SRK7018	CT704SP
FLHT Electra Glide Standard	1988	CK7010	CSK919	SRC7016	SRK7016	CT705SP
FLHT Electra Glide Standard	1994-1997	CK7009		SRC7014	SRK7014	CT701SP
FLHT Electra Glide Standard	1998-2003	CK7008	CSK917	SRC7011	SRK7011	CT703SP
FLHT Electra Glide	1983	CK7012	CSK255	SRC7018	SRK7018	CT704SP
FLHTC Electra Glide Classic	1983-1984	CK7012	CSK255	SRC7018	SRK7018	CT704SP
FLHTC Electra Glide Classic	1985-1989	CK7010	CSK919	SRC7016	SRK7016	CT705SP
FLHTC Electra Glide Classic	1991-1997	CK7009		SRC7014	SRK7014	CT701SP
FLHTC Touring Electra Glide Classic	1990	CK7009	CSK913	SRC7015	SRK7015	CT701SP
FLHTCI Electra Glide Classic	1996-1997	CK7009		SRC7014	SRK7014	CT701SP
FLHTCI Electra Glide Classic	1998-2003	CK7008	CSK917	SRC7011	SRK7011	CT703SP
FLHTCU Electra Glide Classic Ultra	1989	CK7010	CSK919	SRC7016	SRK7016	CT705SP
FLHTCU Touring Electra Glide Classic Ultra	1990	CK7009	CSK913	SRC7015	SRK7015	CT701SP
FLHTCU Ultra Classic	1991-1997	CK7009		SRC7014	SRK7014	CT701SP
FLHTCUI Ultra Classic	1998-2003	CK7008	CSK917	SRC7011	SRK7011	CT703SP
FLHTI Electra Glide Standard	2003	CK7008	CSK917	SRC7011	SRK7011	CT703SP
FLT Classic Tour Glide	1984	CK7011	CSK255	SRC7017	SRK7017	CT704SP
FLT Tour Glide	1984	CK7011	CSK255	SRC7017	SRK7017	CT704SP
FLT Tour Glide	1984	CK7010	CSK919	SRC7016	SRK7016	CT705SP
FLT Tour Glide	1981-1983	CK7012	CSK255	SRC7018	SRK7018	CT704SP
FLTC Tour Glide Classic	1980-1984	CK7012	CSK255	SRC7018	SRK7018	CT704SP
FLTC Tour Glide Classic	1985-1989	CK7010	CSK919	SRC7016	SRK7016	CT705SP
FLTC Tour Glide Classic	1990-1992	CK7009		SRC7014	SRK7014	CT701SP
FLTCU Tour Glide Classic Ultra	1989	CK7010	CSK919	SRC7016	SRK7016	CT705SP
FLTCU Tour Glide Ultra Classic	1990-1996	CK7009		SRC7014	SRK7014	CT701SP
FLHR Road King	2004-2006	CK7008	CSK916	SRC7012	SRK7012	CT703SP
FLHRCI Road King Classic	2005	CK7008	CSK916	SRC7012	SRK7012	CT703SP
FLHRCI Road King Classic	2006	CK7008	CSK915	SRC7013	SRK7013	CT703SP
FLHRCI Road King Classic	1998-2003	CK7008	CSK917	SRC7011	SRK7011	CT703SP
FLHRCI Road King Classic	2004	CK7008	CSK916	SRC7012	SRK7012	CT703SP
FLHRI Road King	2006	CK7008	CSK915	SRC7013	SRK7013	CT703SP
FLHRI Road King	2000-2003	CK7008	CSK917	SRC7011	SRK7011	CT703SP
FLHRI Road King	2004-2005	CK7008	CSK916	SRC7012	SRK7012	CT703SP
FLHRS Road King Custom	2004-2005	CK7008	CSK916	SRC7012	SRK7012	CT703SP

EBC BRAKES CLUTCH KITS



HARLEY-DAVIDSON®



		CK Series Moulded OEM style facings #	CSK Spring Kit #	SRC Series Kit #	SRK Series Kit #	CT Tool #
FLHRS Road King Custom	2006-2007	CK7008	CSK915	SRC7013	SRK7013	CT703SP
FLHRSI Road King Custom	2006	CK7008	CSK915	SRC7013	SRK7013	CT703SP
FLHRSI Road King Custom	2004-2005	CK7008	CSK916	SRC7012	SRK7012	CT703SP
FLHT Electra Glide Standard	2004-2005	CK7008	CSK916	SRC7012	SRK7012	CT703SP
FLHT Electra Glide Standard	2006-2010	CK7008	CSK915	SRC7013	SRK7013	CT703SP
FLHTC Electra Glide Classic	1998-2003	CK7008	CSK917	SRC7011	SRK7011	CT703SP
FLHTC Electra Glide Classic	2004-2005	CK7008	CSK916	SRC7012	SRK7012	CT703SP
FLHTC Electra Glide Classic	2007-2011	CK7008	CSK915	SRC7013	SRK7013	CT703SP
FLHTCI Electra Glide Classic	2006	CK7008	CSK915	SRC7013	SRK7013	CT703SP
FLHTCI Electra Glide Classic	2004-2005	CK7008	CSK916	SRC7012	SRK7012	CT703SP
FLHTCUI Ultra Classic	2004-2005	CK7008	CSK916	SRC7012	SRK7012	CT703SP
FLHTCUI Ultra Classic	2006	CK7008	CSK915	SRC7013	SRK7013	CT703SP
FLHTI Electra Glide Standard	2006	CK7008	CSK915	SRC7013	SRK7013	CT703SP
FLHTI Electra Glide Standard	2004-2005	CK7008	CSK916	SRC7012	SRK7012	CT703SP
FLHTK Ultra Limited	2014-2016	CK7008	CSK917	SRC7011	SRK7011	CT703SP
FLHX Street Glide	2006-2011	CK7008	CSK915	SRC7013	SRK7013	CT703SP
FLTR Road Glide	1998-2003	CK7008	CSK917	SRC7011	SRK7011	CT703SP
FLTR Road Glide	2006-2009	CK7008	CSK915	SRC7013	SRK7013	CT703SP
FLTRI Road Glide	2004-2005	CK7008	CSK916	SRC7012	SRK7012	CT703SP
FLHP Road King Police	2011-2016	CK7008	CSK914	SRC7009	SRK7009	CT703SP
FLHPE Road King Police	2011	CK7008	CSK914	SRC7009	SRK7009	CT703SP
FLHR Road King	2011	CK7008	CSK915	SRC7013	SRK7013	CT703SP
FLHR Road King	2007-2011	CK7008	CSK915	SRC7013	SRK7013	CT703SP
FLHRC Road King Classic	2007-2011	CK7008	CSK915	SRC7013	SRK7013	CT703SP
FLHRC Road King Classic	2014-2016	CK7008	CSK917	SRC7011	SRK7011	CT703SP
FLHTCU Ultra Classic	2007-2011	CK7008	CSK915	SRC7013	SRK7013	CT703SP
FLHTP Electra Glide Standard Police	2017-2023	CK7007	CSK236	SRC7008	SRK7008	CT708SP
FLHTP Electra Glide Standard Police	2011-2016	CK7008	CSK914	SRC7009	SRK7009	CT703SP
FLTRX Road Glide Custom	2010	CK7008	CSK915	SRC7013	SRK7013	CT703SP
FLHR Road King	2011-2013	CK7008	CSK916	SRC7012	SRK7012	CT703SP
FLHR Road King	2015-2016	CK7008	CSK917	SRC7011	SRK7011	CT703SP
FLHR ANV Road King Anniversary	2013	CK7008	CSK916	SRC7012	SRK7012	CT703SP
FLHRC 103 Road King Classic	2011	CK7008	CSK916	SRC7012	SRK7012	CT703SP
FLHRC Road King Classic	2012-2013	CK7008	CSK916	SRC7012	SRK7012	CT703SP
FLHTC 103 Electra Glide Classic	2011	CK7008	CSK916	SRC7012	SRK7012	CT703SP
FLHTC Electra Glide Classic	2012-2013	CK7008	CSK916	SRC7012	SRK7012	CT703SP
FLHTCU 103 Ultra Classic	2011	CK7008	CSK916	SRC7012	SRK7012	CT703SP
FLHTCU TC Ultra Classic Twin-Cooled	2014-2016	CK7008	CSK917	SRC7011	SRK7011	CT703SP
FLHTCU Ultra Classic	2012-2013	CK7008	CSK916	SRC7012	SRK7012	CT703SP
FLHTCU Ultra Classic	2014-2016	CK7008	CSK917	SRC7011	SRK7011	CT703SP
FLHTCUL TC Ultra Classic Low Twin-Cooled	2015-2016	CK7002	CSK235	SRC7003	SRK7003	CT702SP
FLHTCUL Ultra Classic Low	2015-2016	CK7002	CSK235	SRC7003	SRK7003	CT702SP
FLHTK Electra Glide Ultra Limited	2010-2013	CK7008	CSK916	SRC7012	SRK7012	CT703SP
FLHTK ANV Electra Glide Ultra Limited Anniversary	2013	CK7008	CSK916	SRC7012	SRK7012	CT703SP
FLHTKL Ultra Limited Low	2015-2016	CK7002	CSK235	SRC7003	SRK7003	CT702SP
FLHX 103 Street Glide	2011	CK7008	CSK916	SRC7012	SRK7012	CT703SP
FLHX Street Glide	2012-2013	CK7008	CSK916	SRC7012	SRK7012	CT703SP
FLHX Street Glide	2014-2016	CK7008	CSK917	SRC7011	SRK7011	CT703SP
FLHXS Street Glide Special	2014-2016	CK7008	CSK917	SRC7011	SRK7011	CT703SP
FLTRU Road Glide Ultra	2016	CK7008	CSK917	SRC7011	SRK7011	CT703SP
FLTRU Road Glide Ultra	2011-2013	CK7008	CSK916	SRC7012	SRK7012	CT703SP
FLTRX 103 Road Glide Custom	2011-2013	CK7008	CSK916	SRC7012	SRK7012	CT703SP
FLTRX Road Glide	2015-2016	CK7008	CSK917	SRC7011	SRK7011	CT703SP
FLTRXS Road Glide Special	2015-2016	CK7008	CSK917	SRC7011	SRK7011	CT703SP
FLHP Road King Police	2017-2023	CK7007	CSK236	SRC7008	SRK7008	CT708SP
FLHR Road King	2017-2022	CK7007	CSK236	SRC7008	SRK7008	CT708SP
FLHRC Road King Classic	2017-2019	CK7007	CSK236	SRC7008	SRK7008	CT708SP

EBC BRAKES CLUTCH KITS



HARLEY-DAVIDSON®



		CK Series Moulded OEM style facings #	CSK Spring Kit #	SRC Series Kit #	SRK Series Kit #	CT Tool #
FLHRXS Road King Special	2017-2023	CK7007	CSK236	SRC7008	SRK7008	CT708SP
FLHT Electra Glide Standard	2019-2022	CK7007	CSK236	SRC7008	SRK7008	CT708SP
FLHTCU Electra Glide Ultra Classic	2017-2019	CK7007	CSK236	SRC7008	SRK7008	CT708SP
FLHTK Ultra Limited Shrine Edition	2017-2023	CK7007	CSK236	SRC7008	SRK7008	CT708SP
FLHTK Ultra Limited	2017-2023	CK7007	CSK236	SRC7008	SRK7008	CT708SP
FLHTK ANV Electra Glide Ultra Limited Anniversary	2018	CK7007	CSK236	SRC7008	SRK7008	CT708SP
FLHTK ANV Electra Glide Ultra Limited Anniversary	2023	CK7007	CSK236	SRC7008	SRK7008	CT708SP
FLHTKL Ultra Limited Low	2017-2019	CK7007	CSK236	SRC7008	SRK7008	CT708SP
FLHX Street Glide	2017-2023	CK7007	CSK236	SRC7008	SRK7008	CT708SP
FLHXS Street Glide Special	2017-2018	CK7007	CSK236	SRC7008	SRK7008	CT708SP
FLHXS ANV Street Glide Anniversary	2018	CK7007	CSK236	SRC7008	SRK7008	CT708SP
FLHXS ANV Street Glide Anniversary	2023	CK7007	CSK236	SRC7008	SRK7008	CT708SP
FLTRU Road Glide Ultra	2017-2019	CK7007	CSK236	SRC7008	SRK7008	CT708SP
FLTRX Road Glide	2017-2023	CK7007	CSK236	SRC7008	SRK7008	CT708SP
FLTRXS Road Glide Special	2017-2023	CK7007	CSK236	SRC7008	SRK7008	CT708SP
FLTRXS ANV Road Glide Special Anniversary	2023	CK7007	CSK236	SRC7008	SRK7008	CT708SP
FLH Revival	2021	CK7007	CSK236	SRC7008	SRK7008	CT708SP
FLHFB Electra Glide Highway King	2023	CK7007	CSK236	SRC7008	SRK7008	CT708SP
FLHXS Street Glide Special	2019-2023	CK7007	CSK236	SRC7008	SRK7008	CT708SP
FLHXS Street Glide Special Anniversary	2018	CK7007	CSK236	SRC7008	SRK7008	CT708SP
FLHXS Street Glide Special ST	2022-2023	CK7007	CSK236	SRC7008	SRK7008	CT708SP
FLHXS Street Glide ST	2023	CK7007	CSK236	SRC7008	SRK7008	CT708SP
FLTRK Road Glide Limited	2020-2023	CK7007	CSK236	SRC7008	SRK7008	CT708SP
CVO						
FLHTKSE CVO Limited	2017	CK7007	CSK236	SRC7008	SRK7008	CT708SP
FLHXSE CVO Street Glide	2017-2022	CK7007	CSK236	SRC7008	SRK7008	CT708SP
FLHTCUTGSE CVO Trike	2020-2022	CK7007	CSK236	SRC7008	SRK7008	CT708SP
FLHTKSE CVO Ultra Limited	2018-2021	CK7007	CSK236	SRC7008	SRK7008	CT708SP
FLHTKSE ANV CVO Ultra Limited Anniversary	2018	CK7007	CSK236	SRC7008	SRK7008	CT708SP
FLTRXSE CVO Road Glide	2018-2024	CK7007	CSK236	SRC7008	SRK7008	CT708SP
FLTRXSE CVO Road Glide Limited	2022	CK7007	CSK236	SRC7008	SRK7008	CT708SP
FLHTK 103 CVO Limited	2014	CK7002	CSK235	SRC7003	SRK7003	CT702SP
FLTRKSE ANV CVO Road Glide LTD Anniversary	2023	CK7007	CSK236	SRC7008	SRK7008	
FLTRXSTSE CVO Road Glide ST	2024	CK7007	CSK236	SRC7008	SRK7008	
TRIKE						
FLHTCUTG ANV Tri Glide Ultra Classic Anniversary	2013	CK7008	CSK914	SRC7009	SRK7009	CT703SP
FLHTCUTG Tri Glide Ultra Classic	2009-2013	CK7008	CSK914	SRC7009	SRK7009	CT703SP
FLHTCUTG Tri Glide Ultra Classic	2014-2016	CK7002	CSK235	SRC7003	SRK7003	CT702SP
FLHTCUTG ANV Tri Glide Ultra Classic Anniversary	2013-2011	CK7008	CSK914	SRC7009	SRK7009	CT703SP
FLRT Freewheeler	2015-2016	CK7002	CSK235	SRC7003	SRK7003	CT702SP
FLRT Freewheeler	2017-2024	CK7007	CSK236	SRC7008	SRK7008	CT708SP
FLHTCUTG Tri Glide Ultra	2017-2024	CK7007	CSK236	SRC7008	SRK7008	CT708SP
FLHTCUTG Tri Glide Ultra Anniversary	2018	CK7007	CSK236	SRC7008	SRK7008	CT708SP
FLHTCUTG Tri Glide Ultra Anniversary	2023	CK7007	CSK236	SRC7008	SRK7008	CT708SP
FLTRT Road Glide 3	2023-2024	CK7007	CSK236	SRC7008	SRK7008	CT708SP
V-ROD						
VRSCA V-Rod	2002-2006	CK7006	CSK232	SRC7007	SRK7007	CT707SP
VRSCAW V-Rod Wide Tire	2007	CK7006	CSK232	SRC7007	SRK7007	CT707SP
VRSCR Street Rod	2006-2007	CK7006	CSK232	SRC7007	SRK7007	CT707SP
VRSCSE CVO V-Rod	2005-2006	CK7006	CSK232	SRC7007	SRK7007	CT707SP
VRSCX Screamin' Eagle V-Rod	2007	CK7006	CSK232	SRC7007	SRK7007	CT707SP
VRXSE CVO VR Destroyer	2006	CK7006	CSK232	SRC7007	SRK7007	CT707SP
VRSCAW V-Rod	2009-2010	CK7005	CSK233	SRC7006	SRK7006	CT706SP
VRSCAW V-Rod Wide Tire	2008	CK7005	CSK233	SRC7006	SRK7006	CT706SP

BRAKE PADS AND ROTORS FOR POLARIS SLINGSHOT



EBC BRAKE STANDARD ORGANIC BRAKE PADS

A direct equivalent to the OE brake pads, suitable for every day driving. This is our quietest pad formulation for silent braking – progressive braking with excellent cold friction.



EBC BRAKE YELLOW CODED UPGRADE BRAKE PADS

For faster driving, these pads give excellent cold bite and high temperature fade resistance. Stopping distances are drastically reduced, progressive braking with unparalleled pedal feel.



EBC BRAKE ROTORS – OE QUALITY REPLACEMENT

EBC brake rotors are cast using high quality G3000 alloy making this a premium OE quality replacement brake rotor for your Slingshot. Black thermic coated for aesthetics and corrosion protection.



EBC BRAKE ROTORS – BSD BLADE SERIES

The unique BSD blade slot design removes hot gasses from the heart of the braking zone allowing for quicker and more effective dissipation of heat.

COMPLETE VEHICLE STANDARD BRAKE KIT

This money saving kit includes one set of standard organic brake pads for both the front and rear of your vehicle, plus two OE quality brake rotors for the front and one for the rear.

COMPLETE VEHICLE UPGRADE BRAKE KIT

This upgrade kit includes one set of yellow coded upgrade brake pads for both the front and rear of your vehicle, plus two BSD blade slotted brake rotors for the front and one for the rear.



Model	Year	FRONT					REAR				FULL VEHICLE	
		STANDARD BLACK BRAKE PADS (INC. 4 PADS FOR LEFT AND RIGHT FITMENTS)	UPGRADE YELLOW BRAKE PADS (INC. 4 PADS FOR LEFT AND RIGHT FITMENTS)	STANDARD ROTOR LEFT (GROUP)	STANDARD ROTOR RIGHT (GROUP)	BSD SPORT SLOTTED ROTOR KIT (2 PCS)	STANDARD BLACK BRAKE PADS (2 PCS)	UPGRADE YELLOW BRAKE PADS (2 PCS)	STANDARD ROTOR (GROUP)	BSD SPORT SLOTTED ROTOR	COMPLETE STANDARD BRAKE KIT (1 X FRONT PADS, 1 X REAR PADS, 2 X FRONT ROTORS, 1 X REAR ROTOR)	COMPLETE UPGRADE BRAKE KIT (1 X FRONT PADS, 1 X REAR PADS, 2 X FRONT ROTORS, 1 X REAR ROTOR)
Slingshot Base	15-17	FA669/4	FA4669/4	019	019	MD533BSDF	FA670	FA4670	019	MD533BSDR	MDK533STD	MDK533BSD
Slingshot S	18-22	FA669/4	FA4669/4	019	019	MD533BSDF	FA670	FA4670	019	MD533BSDR	MDK533STD	MDK533BSD
Slingshot SL	15-23	FA669/4	FA4669/4	019	019	MD533BSDF	FA670	FA4670	019	MD533BSDR	MDK533STD	MDK533BSD
Slingshot SL SE	22-23	FA669/4	FA4669/4	019	019	MD533BSDF	FA670	FA4670	019	MD533BSDR	MDK533STD	MDK533BSD
Slingshot SLR	17-23	FA669/4	FA4669/4				FA670	FA4670				

FOR FULL APPLICATION INFORMATION PLEASE SEE PAGES 22-23



EBC[®] BRAKES

For **Japanese** and **European Fitments** see separate catalog.

EBC Brakes World Headquarters: Upton Valley Way East, Pineham, Northampton, United Kingdom NN4 9EF

Tel: +44 (0) 1604 583344 E-mail: sales@ebcbrakesuk.com

US Head Office: EBC Brakes USA Inc. 6180 South Pearl Street, Las Vegas, Nevada 89120

Tel: +1 (702) 826-2400 E-mail: sales@ebcbrakesusa.com

www.ebcbrakes.com

The letters EBC form a registered trademark in the United States and most countries worldwide.

Harley® and Harley-Davidson® are registered marks of Harley-Davidson Inc. 3700 W. Juneau Avenue, Milwaukee, WI 53208 United States.

Cover Image: Matt Jensen
@Matt_Jensen